



# VX-1225



USB



Graphic Display



Supervisory System



Quick Coupling Connection



Compatible with FG-CAP



Fast Freezing



Alarms



Dual Output for EEV



Modbus Protocol



Turns off control functions

# 1. SUMMARY

1. SUMMARY .....	2
2. DESCRIPTION .....	3
3. APPLICATIONS .....	4
4. GLOSSARY .....	4
5. TECHNICAL SPECIFICATIONS .....	6
6. ELECTRICAL PRECAUTIONS .....	6
7. <b>VX-1225</b> INSTALLATION .....	7
8. DIMENSIONS .....	7
9. WIRING DIAGRAM .....	8
9.1 <b>FG-CAP</b> .....	9
9.2 POWER SUPPLY INPUT .....	9
10. NAVIGATION KEYS .....	10
11. NAVIGATION TUTORIAL .....	10
12. SUMMARY SCREENS .....	11
12.1 EVAPORATORS SUMMARY SCREENS .....	11
12.2 GRAPHIC SCREENS .....	11
12.3 COLD ROOM SUMMARY SCREEN .....	12
12.4 CONTROL STATUS WARNING SCREEN .....	13
13. CONTROL MENU .....	14
14. MAIN MENU .....	15
14.1 HOW TO CONFIGURE AN APPLICATION ON THE <b>VX-1225</b> .....	17
15. PARAMETERS TABLE .....	18
15.1 CONTROL CONFIGURATION .....	18
15.1.1 COLD ROOM .....	18
15.1.2 EVAPORATORS .....	21
15.1.3 DIGITAL INPUTS .....	34
15.1.4 SENSORS .....	35
15.1.5 ANALOG OUTPUTS .....	35
15.1.6 REFRIGERANT FLUID CURVE .....	36
15.2 SYSTEM CONFIGURATIONS .....	36
15.3 COMMUNICATION CONFIGURATIONS .....	37
15.4 COMMUNICATION WITH SITRAD® .....	38
15.5 DATA MANAGEMENT .....	38
15.6 RESTORE FACTORY SETTINGS .....	38
16. PID .....	39
17. ALARMS .....	40
17.1 ALARMS VIEWING .....	40
17.2 RESETTING IN CASES OF LOSH, LOP, AND MOP ALARMS .....	41
17.3 ALARM TABLES .....	41
17.3.1 SYSTEM ALARMS .....	41
17.3.2 OPERATIONAL ALARMS .....	41
18. IMPORTANT .....	42
19. WARRANTY TERMS .....	43

## 2. DESCRIPTION

The **VX-I225** is a digital evaporator controller designed for the simultaneous control of up to two unipolar electronic expansion valves. It regulates superheating to optimize the energy efficiency of the refrigeration system. This compact and integrated controller provides a complete solution for electronic expansion valve control. In addition to superheating control, the instrument manages room temperature, defrost cycles, pressure, ventilation, protections, and alarms.

The room temperature control includes a normal Setpoint and an economic Setpoint, as well as the fast freezing functionality. For control and monitoring, it features two independent RS-485 communication ports, which can be used for remote control via **Sitrad®** software or other equipment using the MODBUS RTU protocol. It can operate in Driver mode for dedicated superheating control, evaporator pressure control, hot gas defrost pressure control, among others. It has eight configurable inputs for temperature sensors or pressure transducers and four digital inputs for monitoring devices and external actuations.

Its robust hardware includes six dry contact control outputs and two analog outputs for proportional fan control. The **VX-I225** features advanced control logic to optimize thermal performance and reduce the refrigeration system's energy consumption. The **VX-I225** offers a user-friendly interface through a high-brightness OLED display, six interaction keys, and a control menu that provides quick access to the most commonly used commands in the compression system.

Simple to operate and configure, the **VX-I225** is equipped with an internal buzzer (audible alert), a dedicated key, and exclusive screens for alarm monitoring, simplifying system monitoring and fault identification. It also features a real-time clock (RTC) that enables command automation, logs alarm occurrence times, and allows scheduling of defrost cycles and activation of the economic mode. The USB connection can be used to upload and download configuration parameters as well as update its firmware. The **VX-I225** is compatible with the **FG-CAP V.02**.

### 3. APPLICATIONS

- Chiller
- Beverage Display Units;
- Cold Rooms;
- Frozen Food Counters;
- Blast Freezers;
- Rack-Type Refrigeration Equipment (parallel compressors);
- Compressor Stations for supermarkets, logistics storage centers, or climate control systems;
- Condensing Units;
- Plug-ins;

### 4. GLOSSARY

- **Thermostat:** A control device that monitors the temperature of a system and automatically regulates the operation of equipment (such as a heater, air conditioner, or refrigerator) to maintain the temperature as close as possible to a desired value (Setpoint). It generally operates by turning the equipment ON or OFF, or by modulating its power.
- **Pressure switch:** A control device that monitors the pressure of a fluid (liquid or gas) in a system and automatically regulates the operation of equipment (such as a pump, compressor, or valve) to maintain the pressure within a desired range or at a specific value (Setpoint). It often operates by turning the equipment ON or OFF in response to pressure variations. Setpoint: The reference value for a process variable (such as temperature, pressure, flow rate, etc.) that a control system aims to reach and maintain. It is the fundamental parameter around which the control system operates.
- **Hysteresis (or Differential Band):** In ON/OFF control systems, it is the difference between the value of the process variable that activates the output (ON) and the value that deactivates it (OFF). This band prevents the controller output (e.g., a thermostat or pressure switch relay) from switching too rapidly and repeatedly (rapid cycling) when the process variable is near the Setpoint. It reduces equipment wear and system instability.
- **Saturation Temperature (SAT):** The temperature at which a refrigerant changes phase (evaporates or condenses) at a given pressure, known as saturation pressure. At this point, the fluid can coexist in liquid and vapor states in equilibrium. For each saturation pressure, there is a corresponding saturation temperature and vice versa.
- **Superheating (SH):** The temperature difference between the refrigerant vapor at the evaporator outlet (or compressor suction) and its saturation temperature corresponding to the evaporation pressure. It is the heat added to the refrigerant vapor after it has fully evaporated. Proper superheating is critical to ensure that no liquid refrigerant enters the compressor, preventing damage, and to optimize evaporator efficiency.
- **EEV (Electronic Expansion Valve):** A precision control device that actively modulates the flow of liquid refrigerant to the evaporator. Using sensor signals (typically pressure and temperature) and an electronic controller (often a microprocessor), the EEV adjusts the valve opening to maintain optimized superheating at the evaporator outlet under various load and operating conditions. This results in higher energy efficiency, more stable temperature control, and better refrigeration system performance compared to mechanical expansion valves (such as the TXV).
- **MOP (Maximum Operating Pressure):** In expansion valves, refers to a limit on evaporation (or suction) pressure above which the valve restricts or maintains refrigerant flow, even if superheating has not yet been reached. The main goal is to protect the compressor motor from overload, which can occur during startup (pull-down) or after a defrost cycle, when the thermal load on the evaporator is very high, leading to high evaporation pressure.

## 4. GLOSSARY

- **LOP (Low Operating Pressure):** In Electronic Expansion Valves (EEVs), refers to the configurable lower limit for evaporation pressure. The EEV uses this parameter to modulate refrigerant flow, aiming to prevent the evaporator pressure from dropping below this predefined minimum value. This may be critical to protect the compressor, avoid system vacuum, prevent excessive freezing in certain applications, or ensure stable operating conditions.
- **LoSH (Low Superheat):** A critical condition where the refrigerant superheating—i.e., the difference between the vapor temperature at the evaporator outlet and its saturation temperature—is below the safe minimum or the setpoint. This indicates the vapor is not fully dry, posing a risk of liquid return to the compressor (liquid slugging), which can cause severe damage.
- **Driver:** In the context of this product, indicates that the output of the electronic expansion valve is operating independently of the cold room. There are different Driver operation modes available, which can be used to control temperature or pressure processes.
- **Tsuc (Suction temperature):** Refrigerant temperature at the compressor inlet.
- **Psuc (Suction pressure):** Refrigerant pressure at the compressor inlet.
- **OFF:** Inactive or de-energized state.
- **ON:** Active or energized state.



Have this manual at your fingertips with the FG Finder app.

## 5. TECHNICAL SPECIFICATIONS

Power Supply	24Vac 50/60Hz or 24Vdc $\pm 10\%$
Maximum Consumption	1,5 A ac/dc
Controller Operating Temperature	- 20 to 60°C (- 4 to 140°F)
Operating Humidity	10 a 90% UR (without condensation)
Type of Action	Type 1.B
Pollution Degree	II
Software Class	Classe A
Pressure Resolution	0.1 psi / 0.1 bar
Control Pressure	-14,5 to 3191,0 psi / -1,0 to 220,0 bar
Control Temperature	-50 to 200°C / -58 to 392°F
Temperature Resolution	0.1°C / 0.1 °F Across the entire range
Analog Inputs	S1 a S8: Configurable between pressure sensor (4 to 20mA / SB69), or temperature sensor(SB19, SB41, SB59, SB70);
Voltage Output for Pressure Sensors	Voltage output +12V: 12Vdc, Idcmax = 50 mA;
Digital Inputs	I1 a I4: Dry Contact Type Digital Inputs.
Analog Outputs	A1 A2 = 0 - 10 Vdc (máx. 10mA)
Digital Outputs	O1, O2, O3, O4, O5, O6: relay output (SPST) NA, 5(3)A/ 250Vac
USB Interface	Compatible with the USB 2.0 Full-Speed Module (USBFS) standard; Data format for FAT32 pendrive / Maximum size of 32GB pendrive
RS-485 Communication Interface	RS485-1: Not insulated RS485-2: Insulated EXP: Reserved
Product Dimensions (WxHxD)	70,0 x 135,7 x 61,7 mm (2,76" x 5,34" x 2,43")

## 6. WIRING DIAGRAM

 **BEFORE INSTALLING THE CONTROLLER, WE RECOMMEND THAT THE FULL READING OF THE INSTRUCTION MANUAL BE DONE, IN ORDER TO AVOID POSSIBLE DAMAGE TO THE PRODUCT.**

 **PRECAUTION WHEN INSTALLING THE PRODUCT:**

- Before performing any procedure on this instrument, disconnect it from the power supply;
- Certify that the instrument has adequate ventilation, avoiding installation on panels that contain devices that may cause it to operate outside the specified temperature limits;
- Install the product away from sources that may generate electromagnetic disturbances, such as: motors, contactors, relays, solenoid valves, etc.

 **AUTHORIZED SERVICE:**

- Installation or maintenance of the product must be performed only by qualified professionals.

 **ACCESSORIES:**

- Use only Full Gauge Controls original accessories;
- In case of doubt, contact technical support.

**BEING IN CONSTANT DEVELOPMENT, FULL GAUGE CONTROLS RESERVES THE RIGHT TO CHANGE ANY INFORMATION IN THE MANUAL AT ANY TIME, WITHOUT PRIOR NOTICE.**

## 7. VX-1225 INSTALLATION

### 7.1 DIN rail mounting.

To fix the interface on the DIN rail, position the interface fit the top part in place as shown.

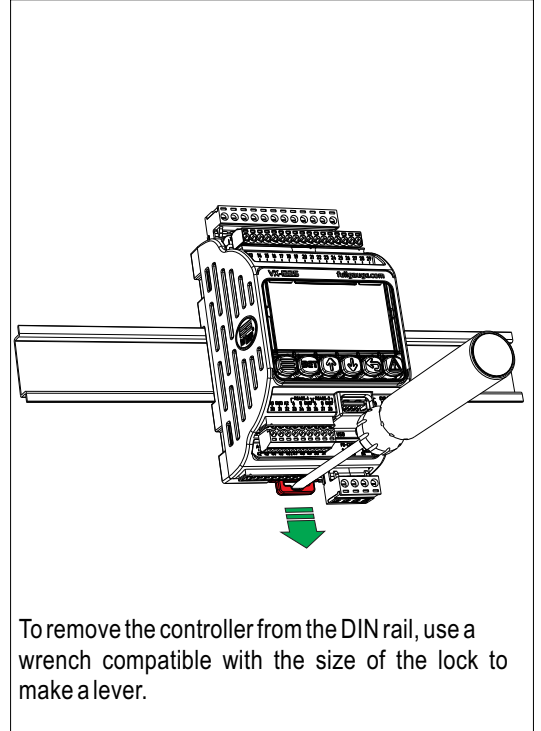
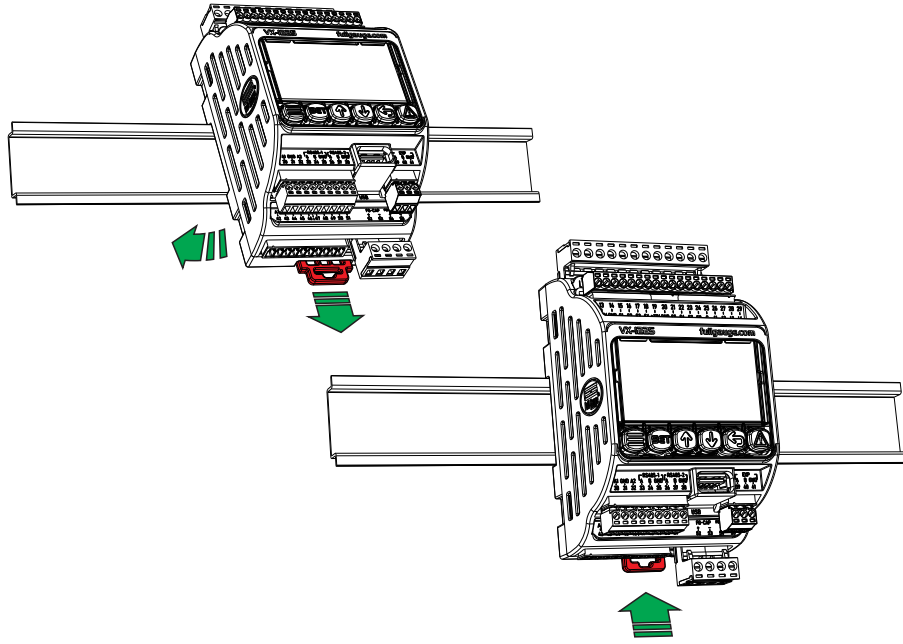

To remove the controller from the DIN rail, use a wrench compatible with the size of the lock to make a lever.

## 8. DIMENSIONS

For a better fixation of the **VX-1225** observe the product dimensions.

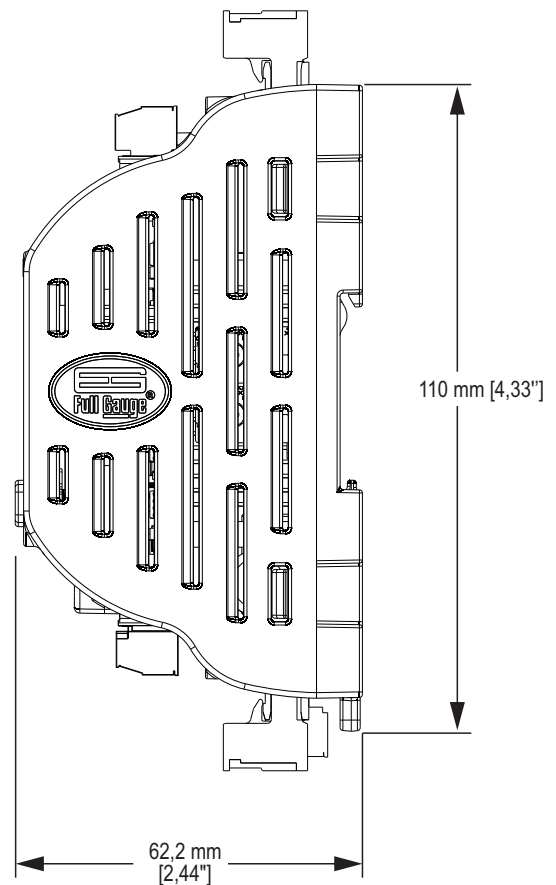
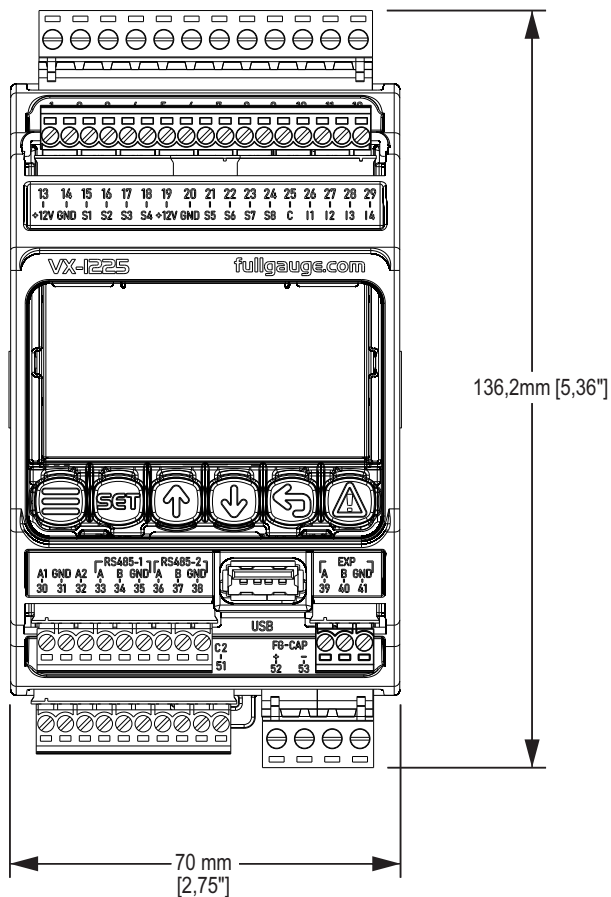

# 9. WIRING DIAGRAM

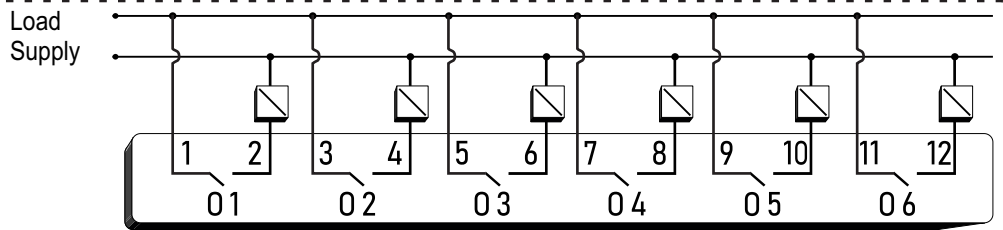

Type 1 connector

Outputs for Load Control

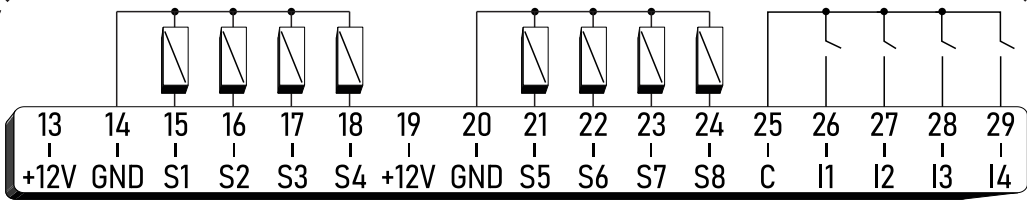

Temperature Sensors

Digital Inputs

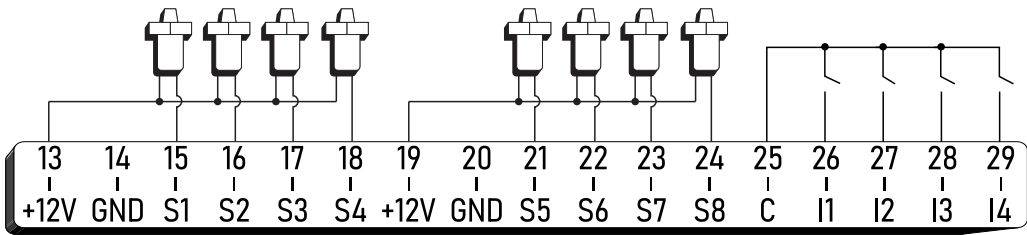

Pressure Sensors

Digital Inputs

Type 2 connector

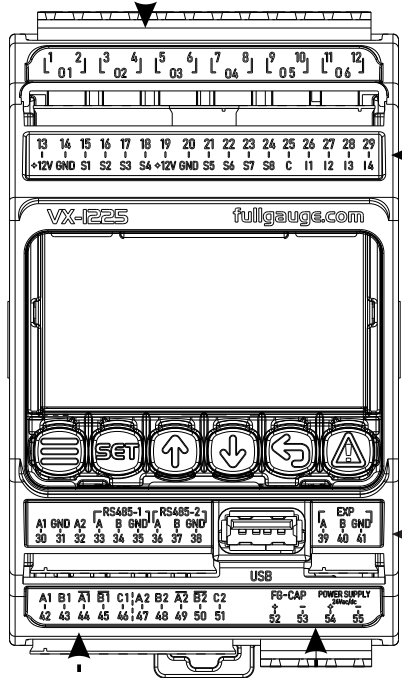

The C and GND terminals are internally connected, except for the GND terminal of the isolated RS485-2 port.

Insulated terminal

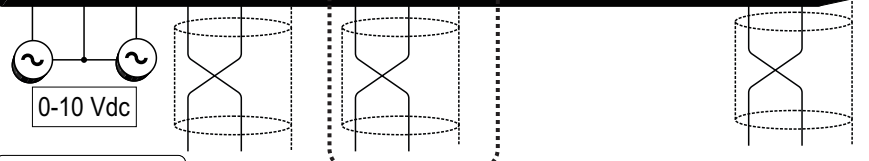
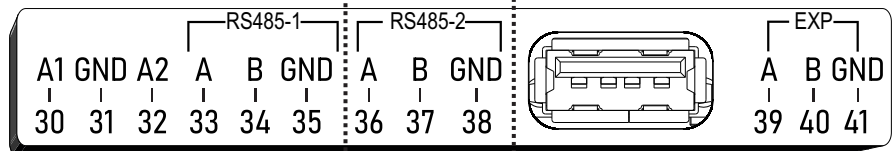

Type 2 connector

Check item 9.1 or 9.2.

Type 2 connector

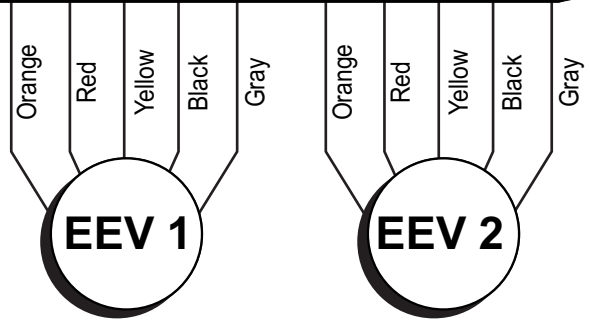
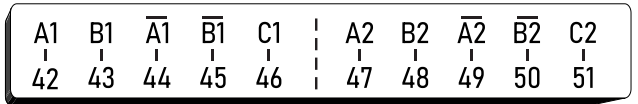

Type 2 connector

**Connector type 1:** For Type 1 connectors (5.0mm), use a #1 Phillips screwdriver or a 3.0mm flat screwdriver. Do not exceed the maximum torque of 0.5 Nm.

**Connector type 2:** For Type 2 connectors (3.5mm), use a #0 Phillips screwdriver or a 2.4mm flat screwdriver. Do not exceed the maximum torque of 0.2 Nm.

**When powering up the controller with control set to OFF, the valve will modulate until it is fully closed.**

**Note:** Up to 8 configurable sensors can be installed for temperature and pressure according to individual configuration.

# 9. WIRING DIAGRAM

## 9.1 FG-CAP

The **FG-CAP V.2** is a device manufactured by Full Gauge, which, at the option and evaluation of the technician, can replace the use of the solenoid valve, helping to close the electronic expansion valve in cases of lack of electrical power. The **FG-CAP V.2** is used in conjunction with the power supply that comes with the product **VX-I225**. The backup system is developed using ultracapacitors that feed a high-efficiency static converter. This configuration allows for highly reliable equipment, with a useful life much longer than equivalent systems with batteries. The charge level in the ultracapacitor is guaranteed by a dedicated electronic system.

With a lack of electrical energy, the charge stored in the **FG-CAP V.2** is sufficient to close the electronic valves. When power returns, the ultracapacitors will be charged again and after the charging time, the refrigeration system will be ready for operation.

The use of **FG-CAP V.2** must be enabled in the configurations of the controller **VX-I225**.

**Note:** The use of **FG-CAP V.2** must be enabled in the system settings on the **VX-I225** controller.

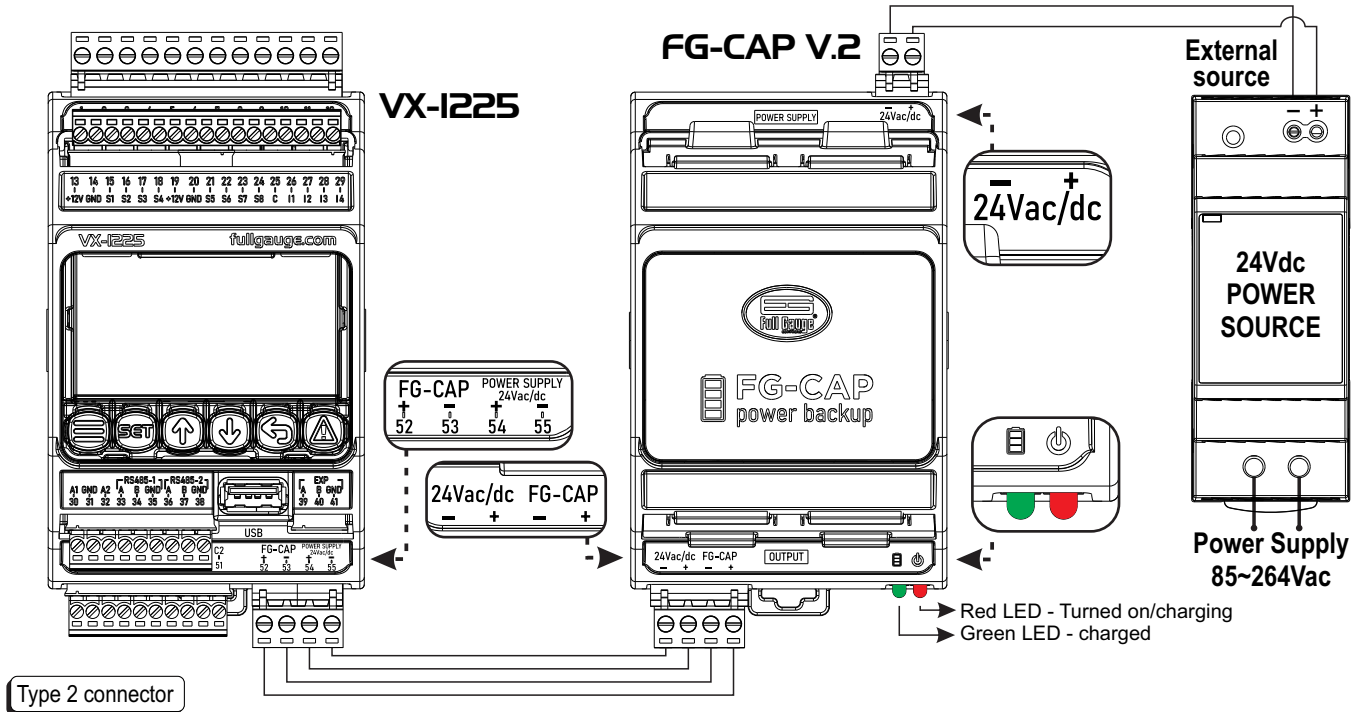

**Note:** Keep the connections at a maximum of 50 cm (19.7") between the products. Use cables of at least 1.0 mm<sup>2</sup> (AWG 17).





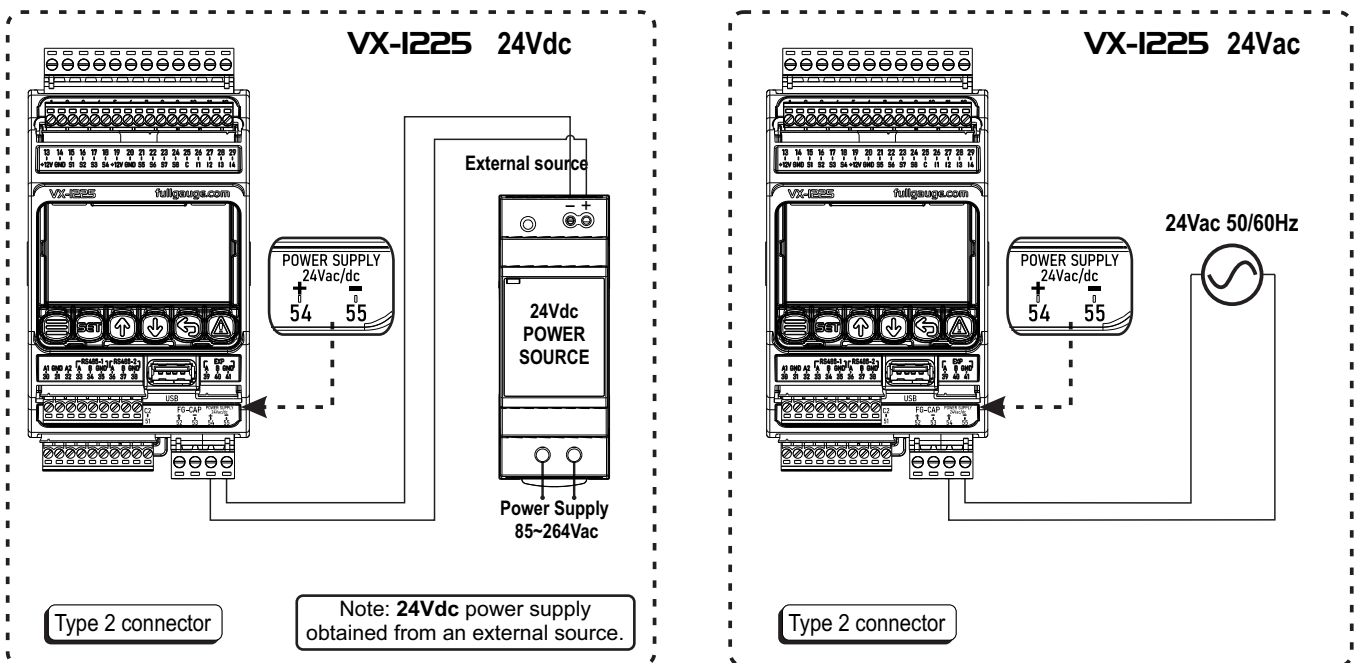



## 9.2 POWER SUPPLY INPUT (WITHOUT FG-CAP):

The **VX-I225** can be powered by a 24Vac power supply or a 24Vdc power supply, in both cases observing the technical specifications in item 5.



## 10. NAVIGATION KEYS

To switch between screens, edit parameters, view advanced functions, and other features, the **VX-I225** has 6 navigation keys on its front panel:

KEY	LEGEND	DESCRIPTION
	<b>MENU</b>	Access the Main Menu and the Control Menu. <b>Control Menu:</b> Press the key  <b>Main Menu:</b> Hold down the key for 2 seconds 
	<b>SET</b>	Confirms the editing of parameters and values.
	<b>INCREASES</b>	Increases values in the parameters and moves the selection to higher options.
	<b>DECREASES</b>	Decreases values in the parameters and moves the selection to lower options.
	<b>RETURN</b>	Returns to the previous screen, with parameters without confirming parameter changes.
	<b>ALARM</b>	Access the active alarms and alarm history view, press once to change the view. To clear the alarm history, view the alarm history and hold down the key  for 4 seconds. <b>Note:</b> requires Administrator access level.



**Note:** To change the language of the controller, press the **MENU**  and **DECREASE**  keys together for 5 seconds.

## 11. NAVIGATION TUTORIAL

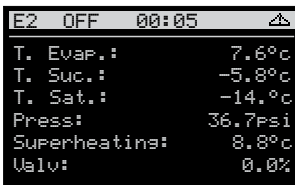

The first screen displays the evaporation temperature, suction temperature, saturation temperature, pressure, superheating, and valve opening percentage.



Using the **INCREASES** or **DECREASES** keys, it is possible to navigate through the other summary screens.

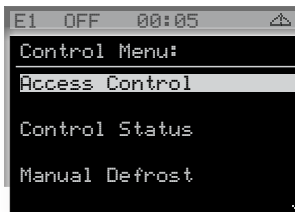

A short press on the **MENU** key takes you to the Control Menu.

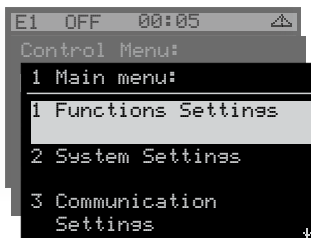

Pressing and holding the **MENU** key for 2 seconds opens the Main Menu, where you can configure the parameters.

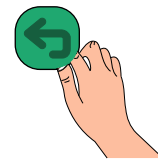

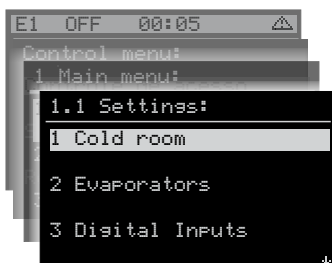

The **RETURN** key is used to go back in the configuration menus; a short press allows you to return to the previous level.



The **SET** key is used to access the selected item.

## 12. SUMMARY SCREENS

### 12.1. Evaporators Summary Screen:

The screen displays the basic information of the evaporators (Evaporator Temperature, Suction Temperature, Saturation Temperature, Pressure, Superheating Temperature, and Valve Opening Percentage). To navigate between the different screens, use the keys  or .

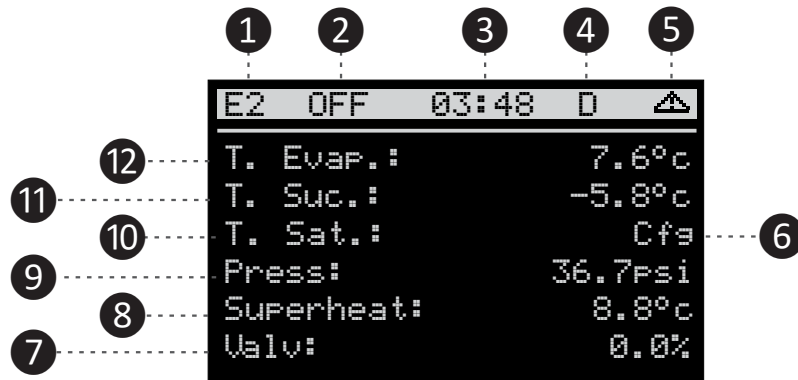

1 — **E2**  
Indicates the corresponding Evaporator.

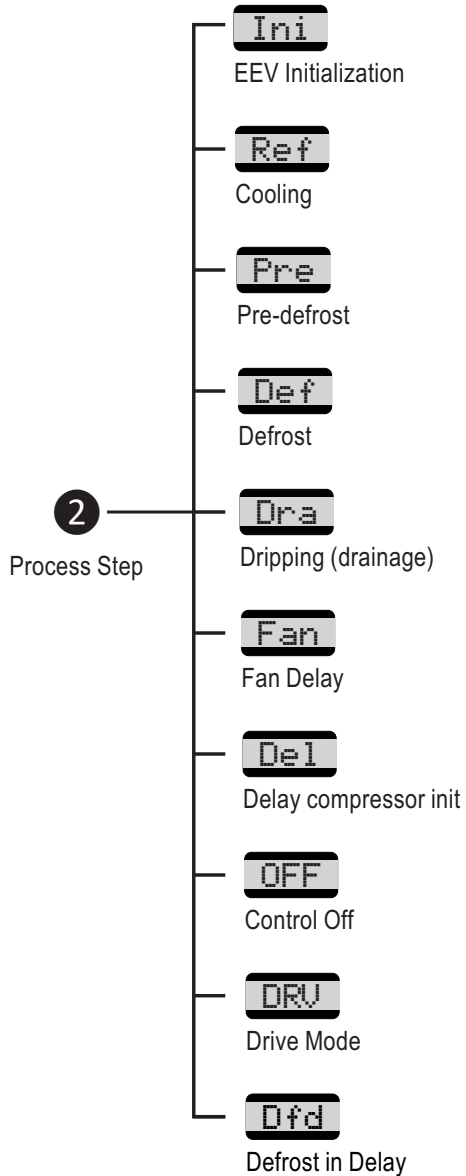

3 — **03:48**  
Process time.

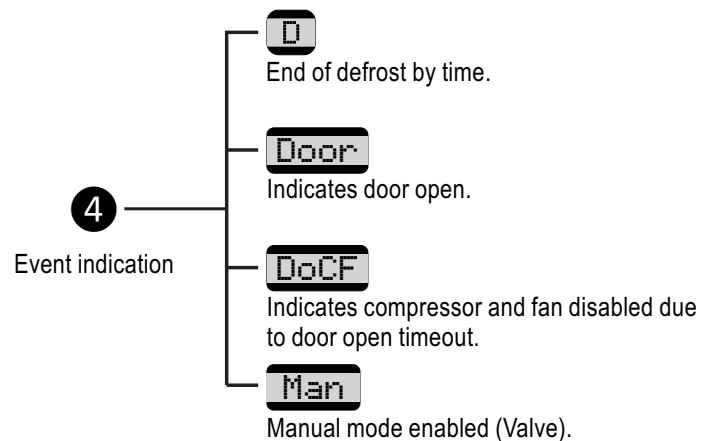

5 —   
Indicates active alarm.

6 — **Cfs**  
Indicates an unconfigured sensor.

7 — **Valv:**  
Informs the opening percentage of the Electronic Expansion Valve (EEV).

8 — **Superheat:**  
Informs the superheating temperature value.

9 — **Press:**  
Informs the pressure value.

10 — **T. Sat.:**  
Informs the saturation temperature.

11 — **T. Suc.:**  
Informs the suction temperature.

12 — **T. Evap.:**  
Informs the evaporator temperature.

## 12. SUMMARY SCREENS

### 12.2. Graphic Screens:

The graphical screen displays the measured values of the evaporator in a manner similar to the installation. To access, press the key  in E1 or E2.

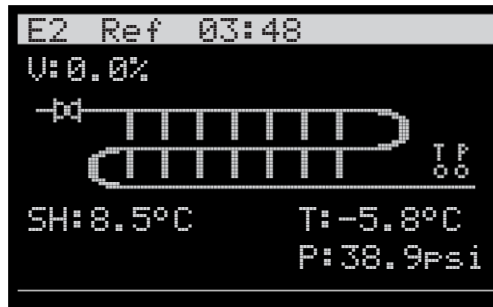

### 12.3. Cold Room Summary Screen:

The cold room summary screen displays the corresponding cold room, date, time, day of the week, and cold room temperature with the setpoint value.

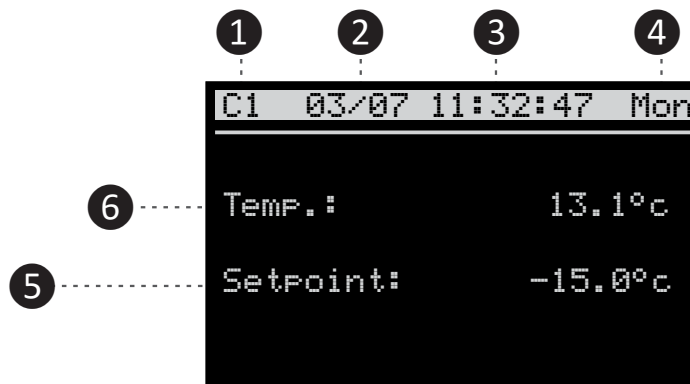

1 - **C1**  
Indicates the corresponding cold room.

2 - **03/07**  
Informs date: Month/ Day.

3 - **11:32:47**  
Informs time: Hour: Minutes: Seconds.

4 - **Mon**  
Informs the day of the week. In the event of an alarm, this information is replaced by .

5 - **Setpoints**

- Setpoint:**  
Informs the configured Setpoint value.
- Setpoint:Fst**  
When Fast Freezing is enabled.
- Setpoint:Eco**  
When Economy Mode is enabled.

6 - **Temp.:**  
Informs the cold room temperature value.

## 12. SUMMARY SCREENS

### 12.4. Control Status Warning Screen:

To configure the parameters related to sensors, digital inputs, load activation outputs, and analog outputs, the Control Status must have the OFF option selected.

To change the Control Status option, it is necessary to access the **Control Menu** → **Control Status**.

If the Control Status is activated (ON) and there is an attempt to change any parameter related to the controller's inputs and outputs, the following message will be displayed, preventing the configuration.

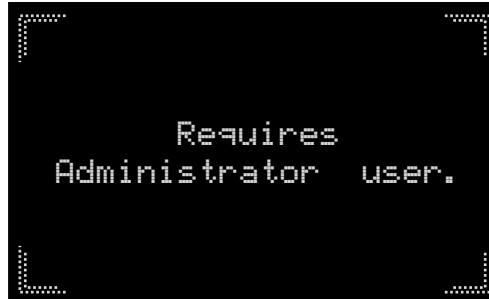

## 13. CONTROL MENU

The Control Menu is accessible by pressing the key . It provides configurations and commands for easy access to the operations of the **VX-I225** controller.

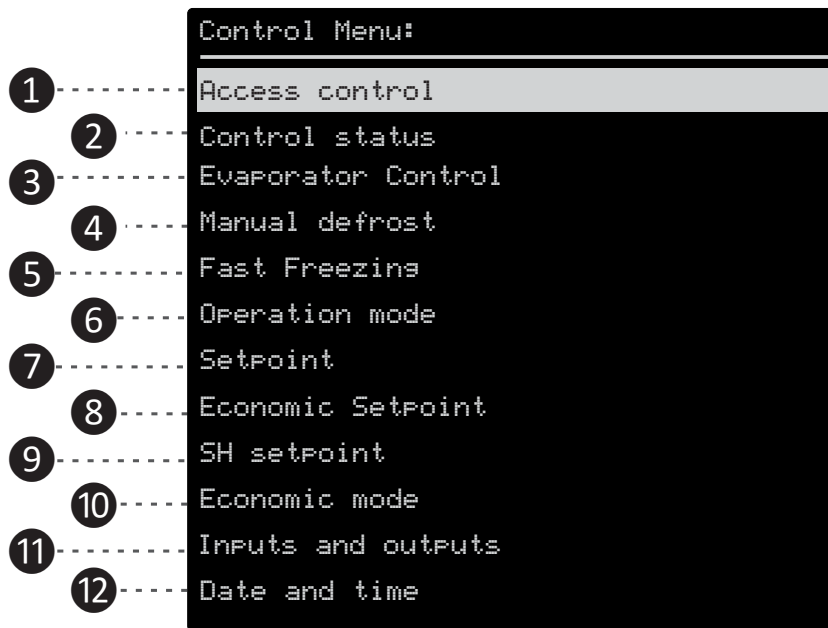

### 1 – Access control:

According to the access level, the user is allowed to perform different actions on the **VX-I225**. Three access levels can be adjusted:

- **Viewer:** Default mode, no code is required.

- **Technician:** Allows changes to some system parameters. The technician level is activated by entering the code 123.

- **Administrator :** Allows changes to all system parameters (typically used during the initial system setup). The Administrator level is activated by entering the code 717.

**Note:** If an invalid code is entered or the **VX-I225** remains inactive for 15 minutes, it automatically returns to Viewer mode.

### 2 – Control Status:

The system control can be turned on (ON) or off (OFF). When turned off, the **VX-I225** only monitors the system without taking any actions.

**Note :** To change certain parameters or import a preset, the controller must be turned off (control status=OFF).

### 3 – Evaporator Control:

Allows manual switching on and off of the evaporator control.

### 4 – Manual defrost:

Manually activates or deactivates defrosting on the evaporators.

### 5 – Fast Freezing:

In Fast Freezing mode, the refrigeration output remains permanently on, thus speeding up the cooling or freezing process.

### 6 – Operation mode:

Defines the operation mode of the EEV in the evaporators, selecting between Automatic or Manual.

### 7 – Setpoint:

Adjusts the temperature/pressure value used as a reference for normal cold room control.

### 8 – Economic setpoint :

When Economy Mode is enabled, adjusts the temperature value used as a reference for cold room control.

### 9 – (SH) Superheating Setpoint:

Adjusts the reference value for superheating control per evaporator.

### 10 – Economic mode:

Enables or disables Economy mode.

### 11 – Inputs and outputs:

A summary of the inputs and outputs of the **VX-I225** is displayed, indicating the sensor reading values, the current state of the digital inputs, and the control outputs.

### 12 – Date and time:

Adjusts the current date and time. This field is important for alarm records and logics that utilize a clock.

## 14. MAIN MENU

The Main Menu is accessible by pressing the  key for at least 2 seconds.

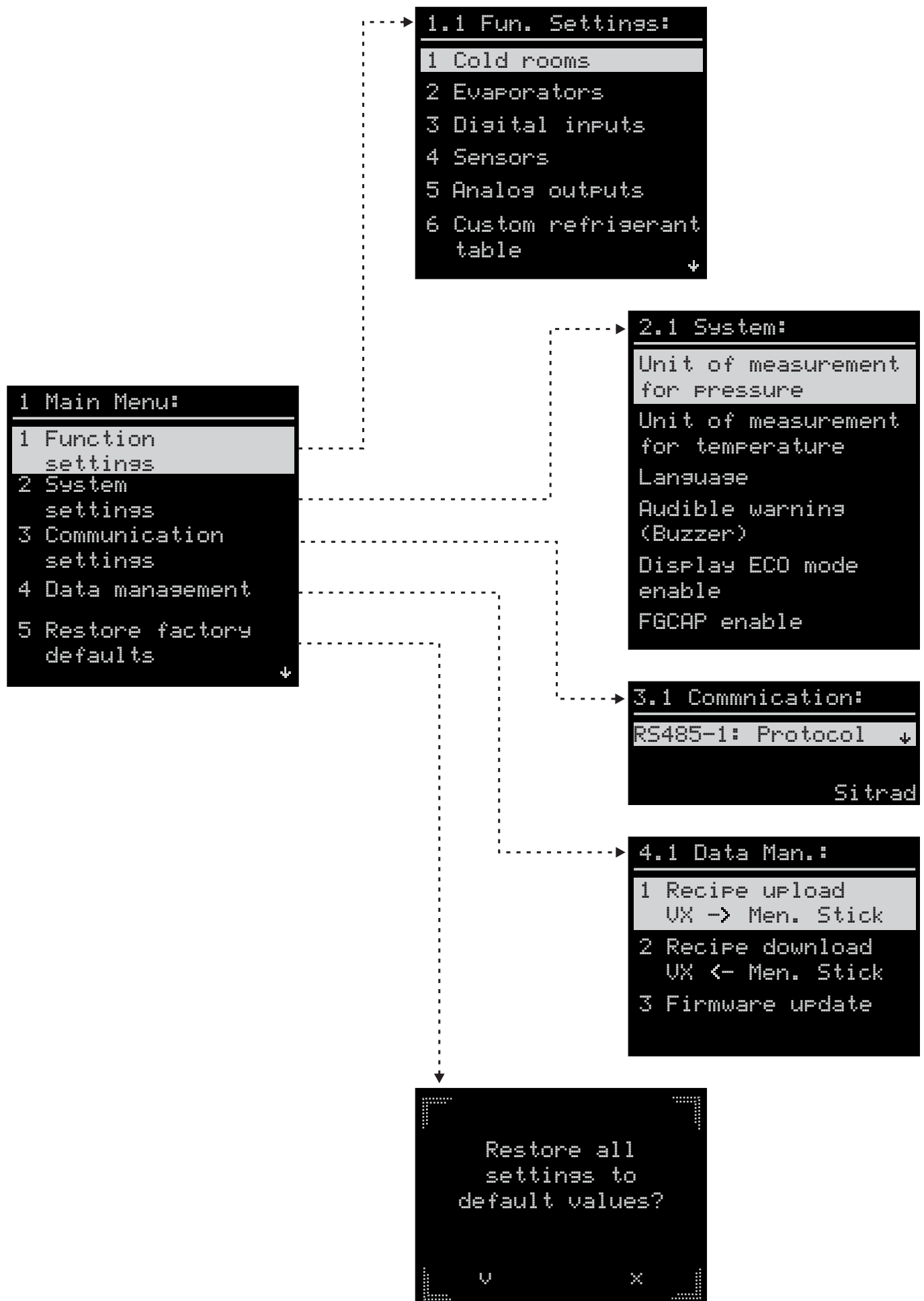

## 14. MAIN MENU

In 1.1 Fun. settings, it is possible to access the second layer of the controller parameters

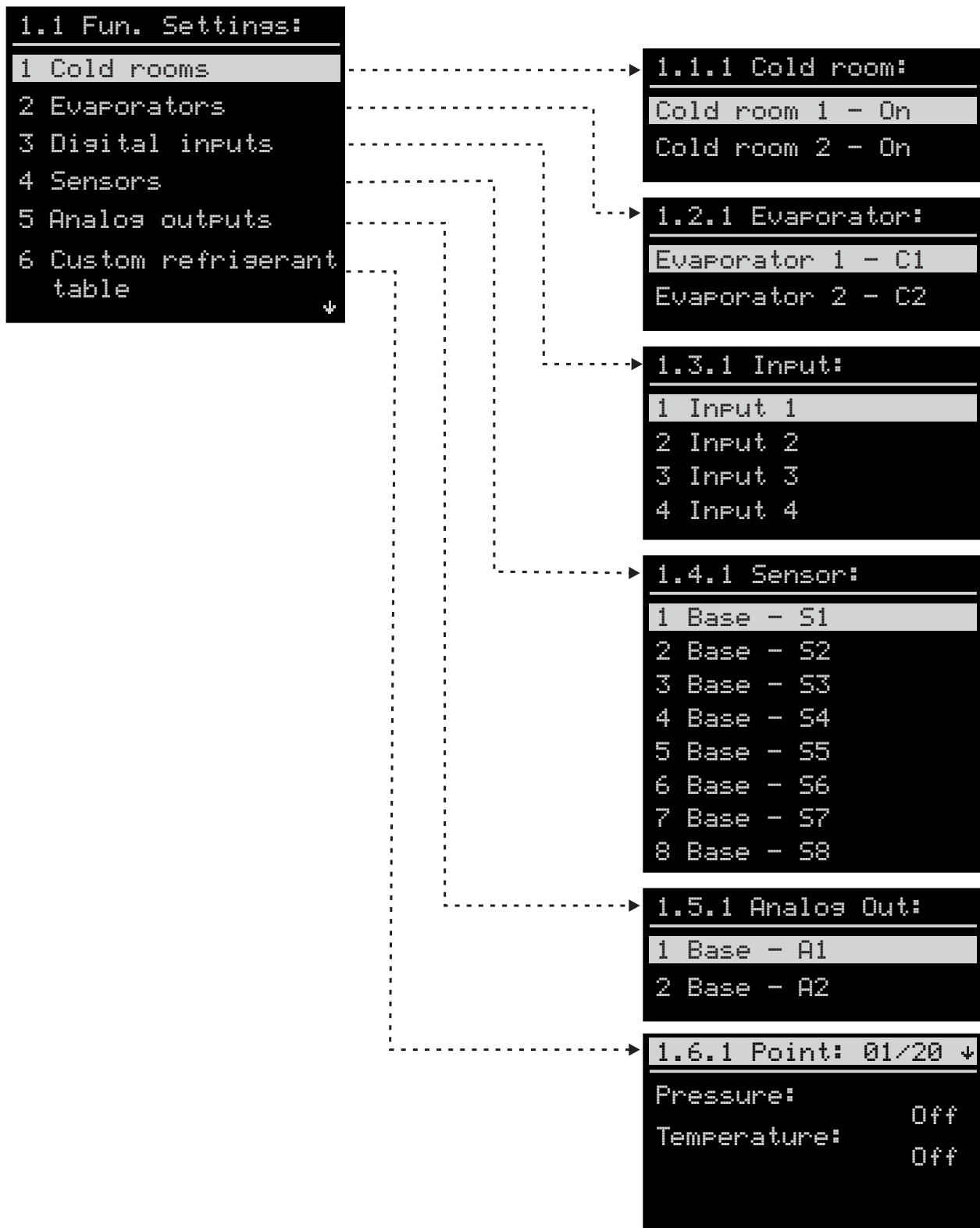

## 14. MAIN MENU

### 14.1 How to Configure an Application on the VX-I225:

The **VX-I225** controller has a flexible configuration that allows it to be used in different applications. Its configuration is divided into two main groups:

#### 1. COLD ROOMS

This group of parameters gathers the settings for the conservation environment, such as the internal temperature of a cold room, freezer, among others. It allows you to adjust the desired temperature for the cold room, energy-saving mode, and alarms.

The **VX-I225** allows the configuration of up to two cold rooms, meaning more environments. Through parameter **1 . 1 . x . 1 - Application Type**, it is possible to enable a cold room.

#### 2. EVAPORATORS

This group of parameters relates to the settings of the evaporator and the electronic expansion valve. It allows you to configure the defrost process, fan operation, and characteristics of the electronic expansion valve.

The operation of the valve is determined through parameter **1 . 2 . x . 1 - Operation Mode**. You can configure it as an electronic expansion valve controller for an evaporator, acting on superheating control, or different types of operation as a valve driver.

Parameter **1 . 2 . x . 2 - Cold Room**, configures the link of the evaporator (EEV) to a cold room (environment). This parameter enables the control of an environment, such as a large cold room, with two evaporators.

Application Examples:

1) Two independent cold rooms:

**1 . 1 . 1 . 1 - Application Type = 1 - Refrigeration**  
**1 . 2 . 1 . 1 - Operation Mode = 1 - Temperature Controller**  
**1 . 2 . 1 . 2 - Cold room = 1 - Cold room 1**

**1 . 1 . 2 . 1 - Application Type = 1 - Refrigeration**  
**1 . 2 . 2 . 1 - Operation Mode = 1 - Temperature Controller**  
**1 . 2 . 2 . 2 - Cold room = 2 - Cold room 2**

2) One cold room / One pressure control (EPR):

**1 . 1 . 1 . 1 - Application Type = 1 - Refrigeration**  
**1 . 2 . 1 . 1 - Operation Mode = 1 - Temperature Controller**  
**1 . 2 . 1 . 2 - Cold room = 1 - Cold room 1**

**1 . 1 . 2 . 1 - Application Type = 0 - Off**  
**1 . 2 . 2 . 1 - Operation Mode = 3 - Drive EPR**  
**1 . 2 . 2 . 2 - Cold room = 0 - No Cold room selected**

3) One cold room with two evaporators:

**1 . 1 . 1 . 1 - Application Type = 1 - Refrigeration**  
**1 . 2 . 1 . 1 - Operation Mode = 1 - Temperature Controller**  
**1 . 2 . 1 . 2 - Cold room = 1 - Cold room 1**

**1 . 1 . 2 . 1 - Application Type = 0 - Turn Off**  
**1 . 2 . 2 . 1 - Operation Mode = 1 - Temperature Control**  
**1 . 2 . 2 . 2 - Cold room = 1 - Cold room 1**

# 15. PARAMETERS TABLE

The address of parameters assigned to different groups but with the same description is presented in the function tables as follows:

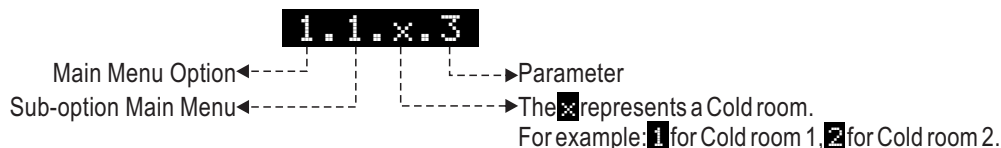

## 15.1 Control Configuration:

### 15.1.1 Cold Room:

Configurable functions intended for cold room control.

FUNCTION	DESCRIPTION	Celsius / psi				Fahrenheit / bar			
		Min	Max	Unit	Default	Min	Max	Unit	Default
1.1.x.1	Application Type	0	2	-	0	0	2	-	0
1.1.x.2	Desired Temperature - Normal Setpoint	1.1.x.4	1.1.x.5	°C	-15,0	1.1.x.4	1.1.x.5	°F	5,0
1.1.x.3	Desired Temperature - Economic Setpoint	1.1.x.4	1.1.x.5	°C	-10,0	1.1.x.4	1.1.x.5	°F	14,0
1.1.x.4	Minimum temperature setpoint allowed for the end user	-50,0	1.1.x.5	°C	-50,0	-58,0	1.1.x.5	°F	-58,0
1.1.x.5	Maximum temperature setpoint allowed for the end user	1.1.x.4	200,0	°C	200,0	1.1.x.4	392,0	°F	392,0
1.1.x.6	Control Differential - Normal Setpoint (Hysteresis)	0,1	20,0	°C	2,0	0,2	36,0	°F	4,0
1.1.x.7	Control Differential - Economic Setpoint (Hysteresis)	0,1	20,0	°C	2,0	0,2	36,0	°F	4,0
1.1.x.8	Time to start economic mode (Monday)	00:00	24:00 (Off)	-	24:00 (Off)	00:00	24:00 (Off)	-	24:00 (Off)
1.1.x.9	Time to start economic mode (Tuesday)	00:00	24:00 (Off)	-	24:00 (Off)	00:00	24:00 (Off)	-	24:00 (Off)
1.1.x.10	Time to start economic mode (Wednesday)	00:00	24:00 (Off)	-	24:00 (Off)	00:00	24:00 (Off)	-	24:00 (Off)
1.1.x.11	Time to start economic mode (Thursday)	00:00	24:00 (Off)	-	24:00 (Off)	00:00	24:00 (Off)	-	24:00 (Off)
1.1.x.12	Time to start economic mode (Friday)	00:00	24:00 (Off)	-	24:00 (Off)	00:00	24:00 (Off)	-	24:00 (Off)
1.1.x.13	Time to start economic mode (Saturday)	00:00	24:00 (Off)	-	24:00 (Off)	00:00	24:00 (Off)	-	24:00 (Off)
1.1.x.14	Time to start economic mode (Sunday)	00:00	24:00 (Off)	-	24:00 (Off)	00:00	24:00 (Off)	-	24:00 (Off)
1.1.x.15	Maximum time in economic mode	0(Off)	999	minutes	120	0(Off)	999	minutes	120
1.1.x.16	Temperature limit for Fast Freezing	-50,0	60,0	°C	-25,0	-58	140	°F	-13
1.1.x.17	Maximum Fast Freezing time	0(Off)	999	minutes	300	0(Off)	999	minutes	300
1.1.x.18	Minimum compressor ON time	0(Off)	9999	seconds	0(Off)	0(Off)	9999	seconds	0(Off)
1.1.x.19	Minimum compressor OFF time	0(Off)	9999	seconds	0(Off)	0(Off)	9999	seconds	0(Off)
1.1.x.20	Compressor on time in case of ambient error	0(Off)	999	minutes	20	0(Off)	999	minutes	20
1.1.x.21	Compressor off time in case of ambient error	0(Off)	999	minutes	10	0(Off)	999	minutes	10
1.1.x.22	Maximum compressor on Time without reaching the setpoint	0(Off)	999	hours	0(Off)	0(Off)	999	hours	0(Off)
1.1.x.23	Control delay time When powering on the controller	0(Off)	999	minutes	0(Off)	0(Off)	999	minutes	0(Off)
1.1.x.24	Ambient temperature sensor	0	8	-	0	0	8	-	0
1.1.x.25	Low ambient temperature alarm	-50,0	200,0	°C	-50,0	-58	392,0	°F	-58
1.1.x.26	High ambient temperature alarm	-50,0	200,0	°C	200,0	-58	392,0	°F	221
1.1.x.27	Time for alarm validation Due to ambient temperature	0(Off)	999	minutes	0(Off)	0(Off)	999	minutes	0(Off)
1.1.x.28	Alarm inhibition time based on room temperature at power-up	0(Off)	999	minutes	10	0(Off)	999	minutes	10
1.1.x.29	Door open time for alarm	0(Off)	999	minutes	5	0(Off)	999	minutes	5
1.1.x.30	Door open time To enable instant defrost	0(Off)	999	minutes	0(Off)	0(Off)	999	minutes	0(Off)
1.1.x.31	Door open time To turn off compressor and fan	0(Off)	999	minutes	0(Off)	0(Off)	999	minutes	0(Off)
1.1.x.32	Door closed time To activate economic mode	0(Off)	999	minutes	0(Off)	0(Off)	999	minutes	0(Off)

## 15. PARAMETERS TABLE

### 1.1.x.1 - Application Type:

0-Off

Cold room not enabled, compressor remains off.

1-Refrigeration

The compressor turns off when the temperature from sensor S1 (ambient) is less than or equal to the Setpoint and turns back on when the temperature from sensor S1 is equal to (Setpoint + Control Differential in refrigeration).

2-Heating

The compressor turns off when the temperature from sensor S1 (ambient) is greater than or equal to the Setpoint and turns back on when the temperature from sensor S1 is equal to (Setpoint - Control Differential in heating).

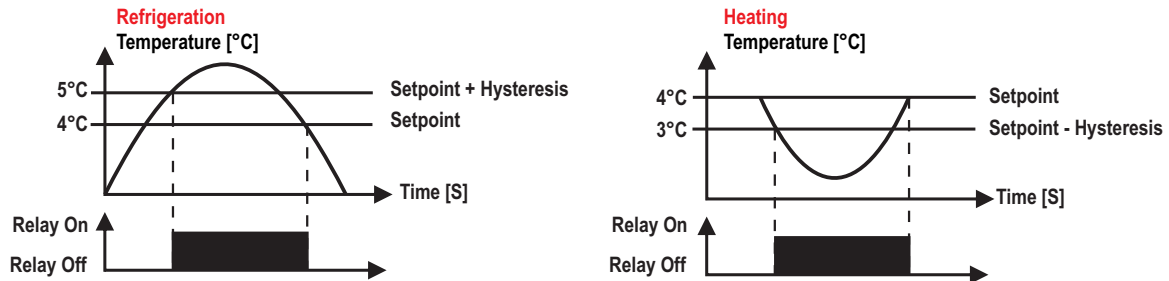

 **Note:** To configure this parameter, control status must be OFF and in Administrator mode.

### 1.1.x.2 - Desired Temperature - Normal Setpoint:

This is the control temperature for normal operation mode.

### 1.1.x.3 - Desired Temperature - Economic Setpoint:

This is the control temperature when the economic operation mode is active.

### 1.1.x.4 - Minimum temperature setpoint allowed for the end user:

### 1.1.x.5 - Maximum temperature setpoint allowed for the end user:

Limits intended to prevent mistakenly setting excessively high or low temperature setpoints, which could lead to high energy consumption by keeping the system continuously running.

### 1.1.x.6 - Control Differential - Normal Setpoint (Hysteresis):

### 1.1.x.7 - Control Differential - Economic Setpoint (Hysteresis):

This is the temperature difference between turning off and turning on the control output.

### 1.1.x.8 - Time to start economic mode (Monday):

Time when the economic setpoint will be activated on Monday. This function can be turned off by setting it to the maximum 0 ff value.

### 1.1.x.9 - Time to start economic mode (Tuesday):

Time when the economic setpoint will be activated on Tuesday. This function can be turned off by setting it to the maximum 0 ff value.

### 1.1.x.10 - Time to start economic mode (Wednesday):

Time when the economic setpoint will be activated on Wednesday. This function can be turned off by setting it to the maximum 0 ff value.

### 1.1.x.11 - Time to start economic mode (Thursday):

Time when the economic setpoint will be activated on Thursday. This function can be turned off by setting it to the maximum 0 ff value.

### 1.1.x.12 - Time to start economic mode (Friday):

Time when the economic setpoint will be activated on Friday. This function can be turned off by setting it to the maximum 0 ff value.

### 1.1.x.13 - Time to start economic mode (Saturday):

Time when the economic setpoint will be activated on Saturday. This function can be turned off by setting it to the maximum 0 ff value.

### 1.1.x.14 - Time to start economic mode (Sunday):

Time when the economic setpoint will be activated on Sunday. This function can be turned off by setting it to the maximum 0 ff value.

### 1.1.x.15 - Maximum time in economic mode:

Allows configuration of the maximum duration of the economic mode. After this time, the setpoint returns to that of normal operation mode. If set to 0 ff, this time is disregarded.

### 1.1.x.16 - Temperature limit for Fast Freezing:

This is the minimum temperature that the instrument can reach during the Fast Freezing process.

## 15. PARAMETERS TABLE

### 1.1.x.17 - Maximum Fast Freezing time:

This is the duration of the Fast Freezing process.

### 1.1.x.18 - Minimum compressor ON time:

This is the minimum time that the compressor will remain on, meaning the time interval between the last start and the next stop. This helps to avoid voltage surges in the electrical network.

### 1.1.x.19 - Minimum compressor OFF time:

This is the minimum time that the compressor will remain off, meaning the time interval between the last stop and the next start. This helps to relieve discharge pressure and increase the compressor's lifespan.

### 1.1.x.20 - Compressor ON time in case of ambient error:

### 1.1.x.21 - Compressor OFF time in case of ambient error:

If the ambient sensor (sensor T1) is disconnected or out of measurement range, the compressor will turn on and off according to the parameters configured in these functions.

### 1.1.x.22 - Maximum compressor on time without reaching the setpoint:

This is the alarm that indicates when the compressor remains on for longer than configured in this function, without reaching the setpoint.

### 1.1.x.23 - Control delay time when powering on the controller:

When the instrument is powered on, it may remain disabled for a time, delaying the start of the process. During this time, it functions only as a temperature indicator. This helps to avoid peaks in electricity demand in case of power failure and return, when multiple devices are connected to the same line. To do this, different times can be set for each device. This delay can be for the compressor or for defrost (when there is defrost on startup).

### 1.1.x.24 - Ambient temperature sensor:

Select the sensor to function as an ambient sensor.

0-Not configured

1-S1

2-S2

3-S3

4-S4

5-S5

6-S6

7-S7

8-S8



**Note:** To configure this parameter, control status must be OFF and in Administrator mode.

### 1.1.x.25 - Low ambient temperature alarm:

This is the ambient temperature (S1) below which the instrument will indicate a low temperature alarm. The differential for turning off the alarm is fixed at 0.1°C/0.1°F. During operation in Fast Freezing, the low temperature alarm is disabled; it is reactivated when the temperature exits the alarm condition.

### 1.1.x.26 - High ambient temperature alarm:

This is the ambient temperature (S1) above which the instrument will indicate a temperature alarm. The differential for turning off the alarm is fixed at 0.1°C/0.1°F.

### 1.1.x.27 - Time for alarm validation due to ambient temperature:

This is the time that an alarm due to ambient temperature (low or high) will remain disabled even under alarm conditions.

### 1.1.x.28 - Alarm inhibition time due to ambient temperature on power-up:

During this time, the alarm remains off, waiting for the system to enter operational mode. Ambient temperature alarms (low or high) are enabled after this time has elapsed or when the setpoint temperature is reached.

**Note:** After this time has elapsed or when the setpoint temperature is reached, the ambient temperature alarm (low or high) will be enabled.

### 1.1.x.29 - Door open time for alarm:

When the door is opened, the door open timer will start. If this time exceeds the time configured in this function, the alarm will be triggered.

### 1.1.x.30 - Door open time to enable instant defrost:

If the door is kept open for a period greater than defined in this function, instant defrost will occur, provided that the temperature in the evaporator (sensor S2) is less than 1.2.x.38 and the ambient temperature (sensor S1) is less than 1.2.x.39.

### 1.1.x.31 - Door open time to turn off compressor and fan:

For safety, if the door open time exceeds the time configured in this function, both the compressor and the fan will be turned off.

## 15. PARAMETERS TABLE

### 1.1.x.32 - Door closed time to activate economic mode:

With the door closed, this parameter defines how long it will take for the economic mode to be activated. The operational setpoint will then control according to the economic setpoint.

### 15.1.2 Evaporators:

Configurable functions for the control of evaporators.

MODE	FUNCTION	DESCRIPTION	Celsius / psi				Fahrenheit / bar			
			Min	Max	Unit	Default	Min	Max	Unit	Default
MODE	1.2.x.1	Operating mode	0	7	-	0	0	7	-	0
	1.2.x.2	Cold Room	0	2	-	0	0	2	-	0
	1.2.x.3	Refrigerant fluid	0	24	-	0	0	24	-	0
	1.2.x.4	Superheating setpoint	0,0	50,0	°C	8,0	0,0	90,0	°F	14,0
	1.2.x.5	Pressure setpoint	1.2.x.6	1.2.x.7	psi	50,0	1.2.x.6	1.2.x.7	bar	3,45
	1.2.x.6	Minimum pressure setpoint allowed for the end user	-14,5	3191,0	psi	-14,5	-1,0	220,0	bar	-1,0
	1.2.x.7	Maximum pressure setpoint allowed for the end user	-14,5	3191,0	psi	232,0	-1,0	220,0	bar	16,0
SUPERHEATING	1.2.x.8	Evaporator type	0	1	-	0	0	1	-	0
	1.2.x.9	Evaporator/Defrost/Heat Recovery Sensor - T2	0	8	-	0	0	8	-	0
	1.2.x.10	Defrost output	0	6	-	0	0	6	-	0
	1.2.x.11	Defrost type	0	2	-	0	0	2	-	0
	1.2.x.12	Defrost mode	0	1	-	0	0	1	-	0
	1.2.x.13	Condition for defrost start	0	5	-	1	0	5	-	1
	1.2.x.14	Interval between defrosts if 1.2.x.13=1 or maximum time without defrosts if 1.2.x.13=2, 3, or 4	1	9999	minutes	240	1	9999	minutes	240
	1.2.x.15	Additional time at the end of the first refrigeration cycle	0(Off)	999	minutes	0(Off)	0(Off)	999	minutes	0(Off)
	1.2.x.16	Evaporator temperature for defrost start if 1.2.x.4=2, 3, or 4	-50,0	105,0	°C	-20,0	-58	221	°F	-4
	1.2.x.17	Temperature difference for defrost start (T1-T2) if 1.2.x.13=3 or 4	-50,0	105,0	°C	15,0	-58	221	°F	59
	1.2.x.18	Low temperature confirmation time to start pre-defrost if 1.2.x.13=2, 3, or 4	0(Off)	999	minutes	10	0(Off)	999	minutes	10
	1.2.x.19	Defrost on controller power-up	No	Yes	-	Yes	No	Yes	-	Yes
	1.2.x.20	Smooth Defrost if 1.2.x.11=0=Electric	10	100(Off)	-	100(Off)	10	100(Off)	-	100(Off)
	1.2.x.21	Enables tray defrosting	No	Yes	-	No	No	Yes	-	No
	1.2.x.22	Tray Resistance Output	0	6	-	0	0	6	-	0
	1.2.x.23	Number of defrosts per day (Monday) if 1.2.x.13=5	1	12	-	4	1	12	-	4
	1.2.x.24	Time to start defrost (Monday) if 1.2.x.13=5	00:00	24:00	-	24:00	00:00	24:00	-	24:00
1.2.x.25	Number of defrosts per day (Tuesday) if 1.2.x.13=5	1	12	-	4	1	12	-	4	
1.2.x.26	Time to start defrost (Tuesday) if 1.2.x.13=5	00:00	24:00	-	24:00	00:00	24:00	-	24:00	
1.2.x.27	Number of defrosts per day (Wednesday) if 1.2.x.13=5	1	12	-	4	1	12	-	4	
1.2.x.28	Time to start defrost (Wednesday) if 1.2.x.13=5	00:00	24:00	-	24:00	00:00	24:00	-	24:00	
1.2.x.29	Number of defrosts per day (Thursday) if 1.2.x.13=5	1	12	-	4	1	12	-	4	
1.2.x.30	Time to start defrost (Thursday) if 1.2.x.13=5	00:00	24:00	-	24:00	00:00	24:00	-	24:00	
1.2.x.31	Number of defrosts per day (Friday) if 1.2.x.13=5	1	12	-	4	1	12	-	4	
1.2.x.32	Time to start defrost (Friday) if 1.2.x.13=5	00:00	24:00	-	24:00	00:00	24:00	-	24:00	

# 15. PARAMETERS TABLE

FUNCTION	DESCRIPTION	Celsius / psi				Fahrenheit / bar				
		Min	Max	Unit	Default	Min	Max	Unit	Default	
DEFROST	1.2.x.33	Number of defrosts per day (Saturday) if 1.2.x.13=5	1	12	-	4	1	12	-	4
	1.2.x.34	Time to start defrost (Saturday) if 1.2.x.13=5	00:00	24:00	-	24:00	00:00	24:00	-	24:00
	1.2.x.35	Number of defrosts per day (Sunday) if 1.2.x.13=5	1	12	-	4	1	12	-	4
	1.2.x.36	Time to start defrosting (Sunday) if 1.2.x.13=5	00:00	24:00	-	24:00	00:00	24:00	-	24:00
	1.2.x.37	Pre-defrost time (gas collection)	0(Off)	999	minutes	0(Off)	0(Off)	999	minutes	0(Off)
	1.2.x.38	Evaporator temperature (T2) to finish defrost.	-50,0	105,0	°C	30,0	-58	221	°F	86
	1.2.x.39	Ambient temperature (T1) to finish defrost.	-50,0	105,0	°C	20,0	-58	221	°F	68
	1.2.x.40	Maximum defrost time (for safety)	1	999	minutes	30	1	999	minutes	30
	1.2.x.41	Drain time (dripping of defrost water)	0(Off)	999	minutes	1	0(Off)	999	minutes	1
	1.2.x.42	Indication for alarm of defrost completed by time	No	Yes	-	No	No	Yes	-	No
	FAN	1.2.x.43	Evaporator Fan Type	0	2	-	0	0	2	-
1.2.x.44		Fan digital output	0	6	-	0	0	6	-	0
1.2.x.45		Fan analog output	0	2	-	0	0	2	-	0
1.2.x.46		Fan operation mode	0	4	-	4	0	4	-	4
1.2.x.47		Fan ON time if 1.2.x.46 = 0 or 4	1	999	minutes	2	1	999	minutes	2
1.2.x.48		Fan OFF time if 1.2.x.46 = 0 (automatic time mode)	1	999	minutes	8	1	999	minutes	8
1.2.x.49		Evaporator temperature for fan return after draining	-50,0	105,0	°C	2,0	-58	221	°F	36
1.2.x.50		Maximum time for fan return after draining (fan-delay)	0(Off)	999	minutes	1	0(Off)	999	minutes	1
1.2.x.51		Fan stop due to high evaporator temperature	-50,0	200	°C	50,0	-58	392	°F	122
1.2.x.52		Open door time to turn off fan	-1(Off)	9999	seconds	0	-1(Off)	9999	seconds	0
1.2.x.53		Variable fan control temperature	-50,0	105,0	°C	-12,0	-58,0	221,0	°F	10,4
1.2.x.54		Control differential of the variable fan (hysteresis)	1,0	105,0	°C	20,0	2	221,0	°F	32,0
1.2.x.55		Minimum speed of the variable fan	0	1.2.x.56	%	30,0	0	1.2.x.56	%	30,0
1.2.x.56		Maximum speed of the variable fan	1.2.x.55	100	%	100	1.2.x.83	100	%	100
1.2.x.57		Variable fan speed with compressor off	0(Off)	1.2.x.56	%	0(Off)	0(Off)	1.2.x.56	%	0(Off)
1.2.x.58		Variable fan startup time at maximum speed	0(Off)	999	seconds	30	0(Off)	999	seconds	30
1.2.x.59		Variable fan time at minimum speed to activate antifreeze protection	0(Off)	999	minutes	0(Off)	0(Off)	999	minutes	0(Off)
1.2.x.60		Variable fan on time at maximum speed during antifreeze protection	10	999	seconds	60	10	999	seconds	60
SUCTION	1.2.x.61	Suction temperature sensor (Tsuc)	0	8	-	0	0	8	-	0
	1.2.x.62	Suction pressure sensor (Psuc)	0	8	-	0	0	8	-	0
	1.2.x.63	Compressor / liquid valve output	0	6	-	0	0	6	-	0
	1.2.x.64	Pump Down pressure	-14,5 (Off)	3191,0	psi	-14,5 (Off)	-1,0(Off)	220,0	bar	-1,0(Off)
	1.2.x.65	Maximum Pump Down time	0(Off)	999	seconds	30	0(Off)	999	seconds	30
	1.2.x.66	Proportional gain (Kp)	0,1	999,9	-	10,0	0,1	999,9	-	10,0
	1.2.x.67	Integral time (Ti)	0,0	999,9	seconds	200,0	0,0	999,9	seconds	200,0
	1.2.x.68	Derivative time (Td)	0,0	999,9	seconds	200,0	0,0	999,9	seconds	200,0
	1.2.x.69	Setpoint - LoSH protection (low superheating)	0,1(Off)	50,0	°C	4,0	0,2(Off)	90,0	°F	7,0
	1.2.x.70	Integral time (Ti) - Low superheating protection	1	999	seconds	20	1	999	sec	20

# 15. PARAMETERS TABLE

FUNCTION	DESCRIPTION	Celsius / psi				Fahrenheit / bar			
		Min	Max	Unit	Default	Min	Max	Unit	Default
1.2.x.71	Setpoint - LOP protection (low evaporation temperature)	-50,0 (Off)	1.2.x.73	°C	-50,0 (Off)	-58 (Off)	1.2.x.73	°F	-58 (Off)
1.2.x.72	Integral time (Ti) - LOP protection (low evaporation temperature)	1	999	seconds	20	1	999	seconds	20
1.2.x.73	Setpoint - MOP protection (high evaporation temperature)	1.2.x.71	200(Off)	°C	200	1.2.x.71	392(Off)	°F	392
1.2.x.74	Integral time (Ti) - MOP protection (high evaporation temperature)	1	999	seconds	20	1	999	seconds	20
1.2.x.75	Validation time for alarm of protections (LoSH, LOP, MOP)	0(Off)	9999	seconds	30	0(Off)	9999	seconds	30
1.2.x.76	Compressor state in case of alarm for protections (ASHL, ALOP, AMOP)	0	7	-	0	0	7	-	0
1.2.x.77	Compressor return time after alarm of protections (LoSH, LOP, MOP)	0	999	minutes	3	0	999	minutes	3
1.2.x.78	Control action in case of superheating sensor error / control in DRIVER mode	0(Off)	1(Man)	-	1(Man)	1(Off)	1(Man)	-	1(Man)
1.2.x.79	Total number of valve steps	20	6500	-	500	20	6500	-	500
1.2.x.80	Operating speed (steps per second)	20	90	steps/seconds	30	20	90	steps/seconds	30
1.2.x.81	Minimum valve opening	0	1.2.x.82	%	0	0	1.2.x.82	%	0
1.2.x.82	Maximum valve opening	1.2.x.81	100	%	100	1.2.x.81	100	%	100
1.2.x.83	Initial valve opening	1.2.x.81	1.2.x.82	%	50	1.2.x.81	1.2.x.82	%	50
1.2.x.84	Initial opening time of the valve	0	9999	seconds	30	0	9999	seconds	30
1.2.x.85	Initial opening time of the valve after defrosting	0	9999	seconds	0	1	9999	seconds	0
1.2.x.86	Valve opening during defrosting with hot gas	1.2.x.81	1.2.x.82	%	0	1.2.x.81	1.2.x.82	%	0
1.2.x.87	System type	0	3	-	0	0	3	-	0
1.2.x.88	Dynamic Superheating Band	0	20	°C	0	0	36	°F	0
1.2.x.89	Reference temperature	-50,0	200,0	°C	-15,0	-58,0	392,0	°F	-5,0
1.2.x.90	Reference Temperature Hysteresis for Floating Superheating	0,1	20,0	°C	2,0	0,1	36,0	°F	4,0

SUCTION

## 15. PARAMETERS TABLE

### 1.2.x.1 - Operating mode:

- 0-OFF
- 1-Temp. Controller = Temperature Control (Grouped) (AGF)
- 2-Driver EEV = Driver for electronic expansion valve (EEV)
- 3-Driver EPR = Evaporator pressure control (EPR)
- 4-DUR Hot Gas Bypass = Hot gas bypass pressure control (DRU)
- 5-Driver Heat Rec. - DIR = Temperature control - direct logic (DIR)
- 6-Driver Heat Rec. - REV = Temperature control - reverse logic (REV)
- 7-Motorized V. Driver = Motorized position valve (DRU)



**Note:** To configure this parameter, control status must be OFF and in Administrator mode.

With the Driver mode active, the instrument disables the temperature controller functions (defrost, fan, and control logics, etc.) and operates only in the control of superheating or pressure and alarms. The outputs change function, describing the control steps and the process state, as per the table:

DESCRIPTION	OUTPUTS		
	DEFR	FAN	COMP
1st stage: initial energized controller	○	○	●
2nd stage: ready to receive external signal and modulate the electronic valve	○	●	●
3rd stage: External signal detected, the electronic valve is modulating	●	●	●
4th stage: In case of alarms: In any driver mode, in case of errors such as AL0004 or AL0x12; (1.2.x.1=2) AL0x06, AL0x07, AL0x08, AL0x09, AL0x10, AL0x11, AL0x14 and AL0x15.	○	○	●

Legend: ○ OFF ● ON

A digital input signal from an external control enables the operation of the electronic valve.

**Note 1:** With 1.2.x.1 = 3, the electronic valve opens when the pressure on transducer P1 increases. The LoSH, MOP, and LOP alarms, as well as the temperature sensors, are disregarded. The pressure reference is defined in 1.2.x.5.

**Note 2:** With 1.2.x.1 = 4, the electronic valve starts controlling the pressure, operating in the opposite manner to EPR control (1.2.x.1 = 3). The LoSH, MOP, and LOP alarms, as well as the temperature sensors, are disregarded. The pressure reference is defined in 1.2.x.5.

**Note 3:** With 1.2.x.1 = 5 or 6, the electronic valve controls the water reservoir temperature for heat recovery applications, where a three-way electronic valve is traditionally used. The reservoir temperature reference is defined in 1.2.x.89. The evaporator sensor (1.2.x.9) is used to measure the reservoir temperature. Other sensors, including alarms, are disregarded.

**Note 4:** To use the evaporator indication in driver mode (1.2.x.1 = 2), enable the sensor and configure band 1.2.x.88 with a value greater than zero.

**Note 5:** With 1.2.x.1 = 7, the electronic valve remains at the initial valve opening position (1.2.x.83) when receiving an external signal (digital input). In the absence of this signal, the valve remains closed.

### 1.2.x.2 - Cold Room:

Selection of the reference cold room for environment control.

- 0-No Cold room
- 1-Cold room 1
- 2-Cold room 2



**Note:** To configure this parameter, control status must be OFF and in Administrator mode.

## 15. PARAMETERS TABLE

### 1.2.x.3 - Refrigerant fluid:

Allows the selection of which refrigerant will be used in the superheating calculation:

- 0- Custom
- 1- R12
- 2- R22
- 3- R32
- 4- R134A
- 5- R290
- 6- R404A
- 7- R407A
- 8- R407C
- 9- R407F
- 10- R410A
- 11- R422A
- 12- R422D
- 13- R427A
- 14- R441A
- 15- R448A
- 16- R449A
- 17- R450A
- 18- R507A
- 19- R513A
- 20- R600A
- 21- R717
- 22- R744
- 23- R1234YF
- 24- R1234ze(E)

### 1.2.x.4 - Superheating Setpoint:

It is the reference value for superheating control.

Superheating indicates how much the vapor temperature is above the saturation temperature (boiling point) at a given pressure.

A pressure transducer is required in the suction line, along with a temperature sensor at the evaporator outlet (useful) or at the compressor inlet (total).

**Superheating = suction temperature - saturated vapor temperature (fluid curve).**

### 1.2.x.5 - Pressure Setpoint:

Pressure value for control when in pressure control mode.

### 1.2.x.6 - Minimum Pressure Setpoint Allowed for End User:

Prevents excessively low setpoint pressures from being mistakenly set.

### 1.2.x.7 - Maximum Pressure Setpoint Allowed for End User:

Prevents excessively high setpoint pressures from being mistakenly set.

### 1.2.x.8 - Evaporator type:

Allows selecting the type of evaporator for the refrigeration system. When the Direct Expansion mode is selected, it means that the controller is operating an electronic expansion valve and thus controlling the superheating. If indirect mode is selected, the electronic expansion valve will be disabled, and the controller will only open and close the liquid valve, as in a fan coil.

0-Direct Exp.

1-Indirect



**Note:** To configure this parameter, control status must be OFF and in Administrator mode.

## 15. PARAMETERS TABLE

### 1.2.x.9 - Evaporator/Defrost/Heat Recovery Sensor - T2:

Allows selecting a sensor for temperature reading at the evaporator.

- 0- Not configured
- 1- S1
- 2- S2
- 3- S3
- 4- S4
- 5- S5
- 6- S6
- 7- S7
- 8- S8

**Note 1:** If 1.2.x.1 = 1 (temperature control), this sensor is the evaporator sensor, used to determine the end of the defrost process.

**Note 2:** If 1.2.x.1 = 5 or 6 (heat recovery), this sensor is the reference for temperature control.



**Note:** To configure this parameter, control status must be OFF and in Administrator mode.

### 1.2.x.10 - Defrost Output:

Address of the output linked to the individual thermostat to perform the defrost.

- 0- Not Configured
- 1- 01
- 2- 02
- 3- 03
- 4- 04
- 5- 05
- 6- 06



**Note:** To configure this parameter, control status must be OFF and in Administrator mode.

### 1.2.x.11 - Defrost Type:

- 0- Electric = Electric defrost (by resistances), where only the defrost output is activated.
- 1- Hot Gas = Hot gas defrost, where the compressor and defrost outputs are activated.
- 2- Natural = Natural defrost (fan on), where only the fan output is activated.

### 1.2.x.12 - Defrost Mode:

- 0- Master = The evaporator has its own defrost logic.
- 1- Dependent = When both evaporators are associated with the same chamber, it allows for defrost synchronization. One evaporator will be the main one, and the other will enter defrost when the main one also enters.

**Note 1:** When configured as Dependent, the defrost of this evaporator is synchronized with the evaporator configured as Master. The defrost control parameters are defined in the Master evaporator.

**Note 2:** In a synchronized defrost process, both evaporators must complete their defrost process before the cooling stage is restarted.

**Note 3:** If no evaporator is configured as Master, each evaporator follows its own defrost parameters.

### 1.2.x.13 - Condition for defrost start:

Determines the condition for the start of defrost.

- 0- Manual only = No automatic defrost.
- 1- Time = Defrost started by time.
- 2- Temperature = Defrost started by temperature.
- 3- Temp. Difference (T1-T2) = Defrost started by temperature difference S1-S2.
- 4- Temp. and Diff (T1-T2) = Defrost started by temperature and temperature difference S1-S2.
- 5- Schedule = Defrost started by the clock.

### 1.2.x.14 - Interval between defrosts if 1.2.x.13 = 1 or maximum time without defrosts if 1.2.x.13 = 2, 3, or 4:

Determines the interval at which defrost will occur, with the time counted from the end of the previous defrost. If the controller is configured to perform defrost by temperature (1.2.x.13 = 2, 3, or 4), this time acts as a safeguard in situations where the evaporator temperature (sensor T2) does not reach the values programmed in 1.2.x.16 or 1.2.x.17. This function determines the maximum time the controller will remain without performing defrost.

### 1.2.x.15 - Additional time at the end of the first refrigeration cycle:

It is used to increase the refrigeration time only during the first refrigeration cycle. In installations with multiple units, it is possible to avoid demand spikes by performing defrosts at different times by assigning different values to this function.

## 15. PARAMETERS TABLE

### 1.2.x.16 - Evaporator temperature for defrost start if 1.2.x.13 = 2 or 4:

When the evaporator temperature (sensor S2) reaches the value configured in this function, the controller will start the confirmation time countdown to initiate the defrost.

### 1.2.x.17 - Temperature difference for defrost start (T1-T2) if 1.2.x.13 = 3 or 4:

When the difference between the room temperature (sensor S1) and the evaporator temperature (sensor S2) is equal to or greater than the value set in this function, the controller will start the confirmation time countdown to initiate the defrost.

### 1.2.x.18 - Low temperature confirmation time to start pre-defrost if 1.2.x.13 = 2, 3, or 4:

If the controller is configured to perform defrost by temperature, when the temperature reaches the configured value, the confirmation time countdown to initiate the pre-defrost begins. During this stage, if the temperature remains low, the pre-defrost is started. Otherwise, if the temperature increases compared to the configured value, the system returns to the refrigeration stage.

### 1.2.x.19 - Defrost controller power-up:

Allows for defrost to be performed when the controller is powered on, such as during a power return (in case of a power outage).

### 1.2.x.20 - Smooth Defrost if 1.2.x.11 = 0 = Electric:

The Smooth Defrost mode allows for a smoother defrost, saving energy and preventing the temperature in the environment from rising as much as in a standard defrost. In this mode, the defrost output remains on while the evaporator temperature (sensor S2) is below 2°C (35.6°F), and once this temperature is exceeded, the output stays on for the configured percentage of time within a 2-minute period.

### 1.2.x.21 - Enables Tray Defrosting:

0- No  
1- Yes

### 1.2.x.22 - Tray Resistance Output:

0- Not Configured  
1- 01  
2- 02  
3- 03  
4- 04  
5- 05  
6- 06



**Note:** To configure this parameter, control status must be OFF and in Administrator mode.

### 1.2.x.23 - Number of Defrosts per Day (Monday) if 1.2.x.13 = 5:

The defrosts are distributed in equal intervals according to the programming of the number of defrosts per day, always considering the preferred time, with the option to adjust the values to 1, 2, 3, 4, 6, 8, or 12. This function is used for Monday programming.

### 1.2.x.24 - Time to Start Defrost (Monday) if 1.2.x.13 = 5:

A preferred (reference) time must be set for one of the defrosts of the day to be carried out. This function is used for Monday programming.

### 1.2.x.25 - Number of Defrosts per Day (Tuesday) if 1.2.x.13 = 5:

The defrosts are distributed in equal intervals according to the programming of the number of defrosts per day, always considering the preferred time, with the option to adjust the values to 1, 2, 3, 4, 6, 8, or 12. This function is used for Tuesday programming.

### 1.2.x.26 - Time to Start Defrost (Tuesday) if 1.2.x.13 = 5:

A preferred (reference) time must be set for one of the defrosts of the day to be carried out. This function is used for Tuesday programming.

### 1.2.x.27 - Number of Defrosts per Day (Wednesday) if 1.2.x.13 = 5:

The defrosts are distributed in equal intervals according to the programming of the number of defrosts per day, always considering the preferred time, with the option to adjust the values to 1, 2, 3, 4, 6, 8, or 12. This function is used for Wednesday programming.

### 1.2.x.28 - Time to Start Defrost (Wednesday) if 1.2.x.13 = 5:

A preferred (reference) time must be set for one of the defrosts of the day to be carried out. This function is used for Wednesday programming.

### 1.2.x.29 - Number of Defrosts per Day (Thursday) if 1.2.x.13 = 5:

The defrosts are distributed in equal intervals according to the programming of the number of defrosts per day, always considering the preferred time, with the option to adjust the values to 1, 2, 3, 4, 6, 8, or 12. This function is used for Thursday programming.

## 15. PARAMETERS TABLE

### 1.2.x.30 - Time to Start Defrost (Thursday) if 1.2.x.13=5:

A preferred (reference) time must be set for one of the defrosts of the day to be carried out. This function is used for Thursday programming.

### 1.2.x.31 - Number of Defrosts per Day (Friday) if 1.2.x.13=5:

The defrosts are distributed in equal intervals according to the programming of the number of defrosts per day, always considering the preferred time, with the option to adjust the values to 1, 2, 3, 4, 6, 8, or 12. This function is used for Friday programming.

### 1.2.x.32 - Time to Start Defrost (Friday) if 1.2.x.13=5:

A preferred (reference) time must be set for one of the defrosts of the day to be carried out. This function is used for Friday programming.

### 1.2.x.33 - Number of Defrosts per Day (Saturday) if 1.2.x.13=5:

The defrosts are distributed in equal intervals according to the programming of the number of defrosts per day, always considering the preferred time, with the option to adjust the values to 1, 2, 3, 4, 6, 8, or 12. This function is used for Saturday programming.

### 1.2.x.34 - Time to Start Defrost (Saturday) if 1.2.x.13=5:

A preferred (reference) time must be set for one of the defrosts of the day to be carried out. This function is used for Saturday programming.

### 1.2.x.35 - Number of defrosts per day (Sunday) if 1.2.x.13=5:

The defrosts are distributed in equal intervals according to the programming of the number of defrosts per day, always considering the preferred time, with the option to adjust the values to 1, 2, 3, 4, 6, 8, or 12. This function is used for Sunday programming.

### 1.2.x.36 - Time to start defrost (Sunday) if 1.2.x.13=5:

A preferred (reference) time must be set for one of the defrosts of the day to be carried out. This function is used for Sunday programming.

### 1.2.x.37 - Pre-defrost time (gas collection):

When the defrost starts, the controller will activate only the fan during this time, in order to take advantage of the residual energy from the gas.

### 1.2.x.38 - Evaporator temperature (T2) to finish defrost:

If the temperature at the evaporator (sensor S2) reaches the adjusted value, the defrost will end as intended, that is, by temperature. This way, the defrost process is optimized.

### 1.2.x.39 - Ambient temperature (T1) to finish defrost:

If the ambient temperature (sensor S1) reaches the adjusted value, the defrost will end by temperature.

### 1.2.x.40 - Maximum defrost time (for safety):

This function adjusts the maximum duration time for a defrost. If, within this period, the defrost is not completed by temperature, a signal will appear on the display (if enabled in 1.2.x.42), indicating that the defrost ended by time and not by temperature. This may occur if the adjusted temperature is too high, the time limit is insufficient, the S2 sensor is disconnected, or it is not in contact with the evaporator.

### 1.2.x.41 - Drain time (dripping of defrost water):

The time required for dripping, that is, for the last drops of water to drain from the evaporator. During this period, all outputs remain off. This function can be turned off by setting it to the minimum value OFF.

### 1.2.x.42 - Indication for alarm of defrost completed by time:

When the defrost is completed by time and not by temperature, the user can be notified through the D indication displayed on the E1 and E2 evaporator screens.

### 1.2.x.43 - Evaporator Fan Type:

0 - No modulation = Fixed-speed fan, on-off type (relay output)

1 - Var. evap. temp. = Variable-speed fan controlled by evaporator temperature

2 - Var. amb. temp. = Variable-speed fan controlled by ambient temperature



**Note:** To configure this parameter, control status must be OFF and in Administrator mode.

## 15. PARAMETERS TABLE

### 1.2.x.44 - Fan digital output:

Address of the digital output of the fan 1 to 6.

- 0- Not configured
- 1- 01
- 2- 02
- 3- 03
- 4- 04
- 5- 05
- 6- 06



**Note:** To configure this parameter, control status must be OFF and in Administrator mode.

### 1.2.x.45 - Fan analog output:

Address of the analog output for the fan inverter.

- 0- Not configured
- 1- A1
- 2- A2



**Note:** To configure this parameter, control status must be OFF and in Administrator mode.

### 1.2.x.46 - Fan operation mode:

0- Time auto = Automatic by time: the fan will remain on when the compressor is running. When the compressor is off, the fan will oscillate according to the times set in 1.2.x.47 and 1.2.x.48;

1- Temp. auto = Automatic by temperature: When the compressor is on, the fan stays on. When the compressor is off, the fan turns on when the ambient temperature is higher than setpoint + 60% of the hysteresis and turns off when the ambient temperature is lower than setpoint + 20% of the hysteresis;

2- Continuous = The fan will always be on;

3- Linked to comp. = Dependent: the fan will be turned on together with the compressor;

4- Time after comp. off = Time after compressor shutdown: after the compressor is turned off, the fan will remain on for the time configured in 1.2.x.47.

**Note 1:** Mode 1 will activate the fan only if the S2 sensor temperature is lower than the S1 sensor temperature.

**Note 2:** Mode 1 will turn on the fan only if the temperature of sensor S2 is lower than the configured setpoint.

### 1.2.x.47 - Fan ON time if 1.2.x.46 = 0 or 4:

This is the time the fan will remain ON.

### 1.2.x.48 - Fan OFF time if 1.2.x.46 = 0 (automatic time mode):

This is the time the fan will remain OFF.

### 1.2.x.49 - Evaporator temperature for fan return after draining:

After drainage, the fan-delay cycle begins. The compressor is turned on immediately because the temperature in the evaporator is high, but the fan will only be turned on after the temperature in the evaporator drops below the adjusted value. This function is used to remove the heat that still exists in the evaporator due to defrosting, preventing it from being released into the environment.

**Note:** This parameter applies to digital (ON-OFF) type fan.

### 1.2.x.50 - Maximum time for fan return after draining (fan-delay):

For safety, if the temperature in the evaporator does not reach the value set in function 1.2.x.49 or if the S2 sensor is disconnected, the fan will return after the time set in this function has passed.

### 1.2.x.51 - Fan stop due to high evaporator temperature:

Its purpose is to turn off the evaporator fan until the ambient temperature approaches the value specified in the refrigeration system design, preventing high temperatures and suction pressures that could damage the compressor. If the evaporator temperature exceeds the adjusted value, the fan is turned off and will be turned on again with a fixed hysteresis of 2°C (3.6°F). This is a great function, for example, when starting up a refrigeration system that has been idle for days or when restocking cold rooms or display cases with merchandise.

### 1.2.x.52 - Open door time to turn off fan:

It is the time that the fan will wait to turn off after the door is opened.

Setting this time to the minimum value OFF will prevent the fan from turning off when the door is opened.

Setting this time to 0 will cause the fan to turn off immediately when the door is opened.

### 1.2.x.53 - Variable fan control temperature:

It is the lower temperature limit, below which the fan will operate at maximum speed (if 1.2.x.43 = 1) or minimum speed (if 1.2.x.43 = 2).

## 15. PARAMETERS TABLE

### 1.2.x.54 - Control differential of the variable fan (hysteresis):

If 1.2.x.43 = 1, this parameter represents the temperature band where the fan will vary its speed between the maximum and minimum limits. The fan will turn off when the evaporator temperature (S2 sensor) reaches the upper limit (1.2.x.53+1.2.x.54).

If 1.2.x.43=2, the references will be functions 1.1.x.2 and 1.1.x.6 or 1.1.x.3 and 1.1.x.7.

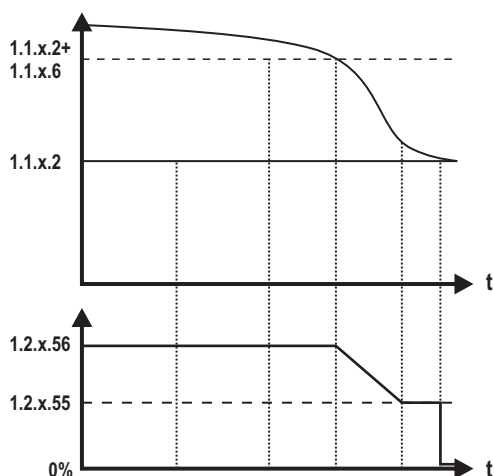

1.1.x.2 = Desired temperature (setpoint)  
 1.1.x.3 = Desired temperature (economical setpoint)  
 1.1.x.6 = Control differential of the operating setpoint  
 1.1.x.7 = Control differential of the economical setpoint  
 1.2.x.53 = Fan control temperature  
 1.2.x.54 = Fan control differential (hysteresis)  
 1.2.x.55 = Minimum fan speed  
 1.2.x.56 = Maximum fan speed



**Note:** If the economical mode is enabled, functions 1.1.x.2 and 1.1.x.6 will be replaced by 1.1.x.3 and 1.1.x.7, respectively.

### 1.2.x.55 - Minimum speed of the variable fan:

### 1.2.x.56 - Maximum speed of the variable fan:

Defines the minimum and maximum speeds of the fan.

### 1.2.x.57 - Variable fan speed with compressor off:

Defines the variable fan speed when the compressor is off.

If the defrost is of the natural type, the fan will remain on at this speed during the pre-defrost and defrost stages.

Setting this parameter to the minimum value OFF will cause the variable fan to turn off at the same time as the compressor.

### 1.2.x.58 - Variable fan startup time at maximum speed:

It is possible to start the fan at maximum speed for the time defined in this parameter.

The purpose of this feature is to apply high torque to facilitate the fan start-up.

### 1.2.x.59 - Variable fan time at minimum speed to activate antifreeze protection:

The maximum time the variable fan will operate continuously at the minimum speed set in 1.2.x.55.

This process of periodic speed acceleration helps prevent ice buildup on the fan blades.

### 1.2.x.60 - Variable fan ON time at maximum speed during antifreeze protection:

Maximum time the variable fan stays at maximum speed (1.2.x.56) during antifreeze protection. This parameter works in conjunction with 1.2.x.59.

### 1.2.x.61 - Suction temperature sensor (Tsuc):

Selects the sensor to measure suction temperature.

0- Not configured

1- S1

2- S2

3- S3

4- S4

5- S5

6- S6

7- S7

8- S8



**Note:** To configure this parameter, control status must be OFF and in Administrator mode.

## 15. PARAMETERS TABLE

### 1.2.x.62 - Suction pressure sensor (Psuc):

Selects the sensor to measure suction pressure.

0- Not configured

1- S1

2- S2

3- S3

4- S4

5- S5

6- S6

7- S7

8- S8



**Note:** To configure this parameter, control status must be OFF and in Administrator mode.

### 1.2.x.63 - Compressor / liquid valve output:

Selects the output for the compressor.

0- Not configured

1- O1

2- O2

3- O3

4- O4

5- O5

6- O6



**Note:** To configure this parameter, control status must be OFF and in Administrator mode.

### 1.2.x.64 - Pump Down pressure:

When the temperature setpoint (1.1.x.2 or 1.1.x.3) is reached, the compressor will not be turned off if the transducer pressure is higher than the value configured in this function. The compressor will remain on until the pressure drops below this value.

This function can be disabled by adjusting it to the minimum OFF value.

### 1.2.x.65 - Maximum Pump Down time:

This is the maximum time that the compressor will remain on during the Pump Down process (for safety). After this time, the compressor will be turned off. If this function is set to the minimum value 0 OFF, the compressor will only be turned off if the transducer pressure is lower than 1.2.x.64.

### 1.2.x.66 - Proportional gain (Kp):

Determines the proportional gain of the PID control algorithm.

### 1.2.x.67 - Integral time (Ti):

Determines the integral time of the PID control algorithm.

### 1.2.x.68 - Derivative time (Td):

Determines the derivative time of the PID control algorithm.

### 1.2.x.69 - Setpoint - LoSH protection (low superheating):

When the superheating temperature is below this value, the low superheating alarm will activate, gradually closing the electronic expansion valve (EEV).

**Note:** This parameter has a fixed hysteresis of 0.3°C (0.6°F).

### 1.2.x.70 - Integral time (Ti) - Low superheating protection:

When the superheating temperature is below the LoSH protection setpoint (Low superheating – 1.2.x.69), the integral time Ti (1.2.x.67) is replaced by the value set in 1.2.x.70 to accelerate system recovery. After recovery, the control returns to the value defined in 1.2.x.67.

### 1.2.x.71 - Setpoint - LOP protection (low evaporation temperature):

When the evaporation temperature is below this value, the electronic expansion valve (EEV) will gradually open to increase the system's evaporation temperature. This process will continue until the evaporation temperature reaches the value set in this function.

### 1.2.x.72 - Integral time (Ti) - LOP protection (low evaporation temperature):

When the evaporation temperature is below the LOP protection setpoint (Low evaporation temperature – 1.2.x.71), the integral time Ti (1.2.x.67) is replaced by the value configured in 1.2.x.72 to accelerate system recovery. After recovery, the integral time returns to the value configured in 1.2.x.67.

## 15. PARAMETERS TABLE

### 1.2.x.73 - Setpoint - MOP protection (high evaporation temperature):

When the evaporation temperature exceeds the value set in this function, the controller gradually closes the electronic expansion valve (EEV) to keep the evaporation temperature below the established value. This protection prevents the superheating from reaching an extremely low value, which could cause liquid return to the compressor.

**Note:** Parameters 1.2.x.71 and 1.2.x.73 have a fixed hysteresis of 0.5°C (0.9°F).

### 1.2.x.74 - Integral time (Ti) - MOP protection (high evaporation temperature):

When the evaporation temperature is above the MOP protection setpoint (High evaporation temperature – 1.2.x.73), the integral time Ti (1.2.x.67) is replaced by the value configured in 1.2.x.74 to accelerate system recovery. After recovery, the integral time returns to the value configured in 1.2.x.67

### 1.2.x.75 - Validation time for alarm of protections (LoSH, LOP, MOP):

It is the time during which a protection alarm (LoSH, LOP, or MOP) will remain disabled even if the conditions for the alarm are met.

### 1.2.x.76 - Compressor state in case of alarm for protections (ASHL, ALOP, AMOP):

0- Do not turn off = Compressor does not turn off in case of ASHL, ALOP, or AMOP alarms;

1- Turn off in ASHL = Compressor turns off in case of ASHL alarm;

2- Turn off in ASHL/ALOP = Compressor turns off in case of ASHL or ALOP alarms;

3- Turn off in ASHL/AMOP = Compressor turns off in case of ASHL or AMOP alarms;

4- Turn off in ALOP = Compressor turns off in case of ALOP alarm;

5- Turn off in ALOP/AMOP = Compressor turns off in case of ALOP or AMOP alarms;

6- Turn off in AMOP = Compressor turns off in case of AMOP alarm;

7- Turn off in all = Compressor turns off in case of any ASHL, ALOP, or AMOP alarm.

### 1.2.x.77 - Compressor return time after alarm of protections (ALoSH, ALOP, AMOP):

It defines the time that the compressor remains off after the activation of an alarm, according to the option set in 1.2.x.76.

### 1.2.x.78 - Control action in case of superheating sensor error / control in DRIVER mode:

0- OFF - Closes the electronic valve, and all control outputs will be turned off.

1- Man - Keeps the valve fixed at the position configured in (1.2.x.83 - Initial valve opening) and all control outputs operating normally.

### 1.2.x.79 - Total number of valve steps:

This function defines the number of steps specified for the electronic expansion valve (EEV).

### 1.2.x.80 - Operating speed (steps per second):

This function defines the operating speed according to the specifications of the electronic expansion valve (EEV).

### 1.2.x.81 - Minimum valve opening:

This is the minimum percentage opening value that the electronic expansion valve will reach.

### 1.2.x.82 - Maximum valve opening:

This is the maximum percentage opening value that the electronic expansion valve will reach.

### 1.2.x.83 - Initial valve opening:

This function defines the percentage opening value of the electronic expansion valve when starting the control.

### 1.2.x.84 - Initial opening time of the valve:

This is the maximum time that the electronic expansion valve will remain at the opening defined in function 1.2.x.83.

### 1.2.x.85 - Initial opening time of the valve after defrosting:

This is the maximum time the electronic expansion valve will remain at the opening defined in function 1.2.x.83 after the defrost stage.

**Note:** if this parameter is set to zero, the time defined in 1.2.x.84 will be respected.

### 1.2.x.86 - Valve opening during defrosting with hot gas:

In this function, the percentage opening value of the electronic expansion valve is defined during the hot gas defrost process.

### 1.2.x.87 - System type:

0- Stable = Stable system;

1- Oscillatory = Oscillatory system;

2- Turbulent = Turbulent system;

3- Unstable = Unstable system;

## 15. PARAMETERS TABLE

### 1.2.x.88 - Dynamic Superheating Band:

If enabled, this function defines the maximum increment that the Superheating Setpoint (1.2.x.4) will have in the region defined by (1.1.x.2+1.1.x.6).

**Example:** If 1.2.x.4 = 8.0°, 1.1.x.2 = -15.0°, 1.1.x.6 = 2.0°, and 1.2.x.88 = 4.0°:

The superheating will be adjusted to 8.0° as long as the ambient temperature is above -13° (1.1.x.2 - 1.1.x.6). Between -13°C and -15°C, it will increase linearly until it reaches the maximum of 12° (1.2.x.4 + 1.2.x.88) when the ambient temperature is close to -15°.

**Observation 1:** The operation in driver mode will be available only if 1.2.x.1 = 2. In this operating mode (without a chamber), the parameter 1.1.x.2 will be replaced by parameter 1.2.x.89 (Reference Temperature), and the parameter 1.1.x.6 will be replaced by parameter 1.2.x.90 (Reference Temperature Hysteresis).

**Observation 2:** The evaporator sensor (T2) must be enabled for the function to be available.

**Observation 3:** The control logic adjusts automatically if the economic setpoint is activated.

### 1.2.x.89 - Reference Temperature:

If the evaporator is configured in Driver mode without a link to the cold room (1.2.x.1 = 2), this parameter represents the room temperature for calculating the floating superheating band.

If 1.2.x.1 = 5 or 6, this parameter represents the desired temperature for control.

### 1.2.x.90 - Reference Temperature Hysteresis for Floating Superheating:

If the evaporator is configured in driver mode, without connection to the chamber (1.2.x.1 = 2), this parameter represents the desired hysteresis for the chamber.

# 15. PARAMETERS TABLE

## 15.1.3 Digital Inputs:

These parameters allow configuring the digital inputs by linking them to a specific evaporator, defining the input function, digital input address, and contact type.

	FUNCTION	DESCRIPTION	Min	Max	Unit.	Standard.
DIGITAL INPUTS	1.3.x.1	Usage Link.	0	4	-	0
	1.3.x.2	Input Function.	0	8	-	0
	1.3.x.3	Digital Input Address.	0	4	-	0
	1.3.x.4	NO-NC Contact Type.	NO	NC	-	NO

### 1.3.x.1 - Usage Link:

Associates the digital input to one evaporator or two evaporators.

- 0 - OFF
- 1 - Evaporator 1
- 2 - Evaporator 2
- 3 - All

 **Note:** To configure this parameter, control status must be OFF and in Administrator mode.

### 1.3.x.2 - Input Function:

Specifies the operating mode of the digital input:

- 0 - Digital input disabled = (None)
- 1 - Door Sensor = (Contact)
- 2 - ON-OFF Control = (Contact)
- 3 - Defrost = (Push button)
- 4 - Fast Freezing = (Push button)
- 5 - Run/Stop = (Contact)
- 6 - ECO Setpoint = (Push button)
- 7 - External Alarm 1 = (Contact)
- 8 - External Failure 1 = (Contact)

 **Note:** To configure this parameter, control status must be OFF and in Administrator mode.

 **Note:** The input function options are available in specific cases:  
 1, 4, 6 - available only in temperature control mode;  
 2 - always available;  
 3 - available only in temperature control mode and driver mode for superheating;  
 5 - available only in driver mode;  
 7 and 8 - available only in controller mode.

### 1.3.x.3 - Digital Input Address:

Specifies the digital input address:

- 0 - Not Configured
- 1 - I1
- 2 - I2
- 3 - I3
- 4 - I4

 **Note:** To configure this parameter, control status must be OFF and in Administrator mode.

### 1.3.x.4 - NO-NC Contact Type:

Defines the input activation state. NO is triggered by a normally open contact, and NC is triggered by a normally closed contact.

- 0 - NO
- 1 - NC



 **Note:** To configure this parameter, control status must be OFF and in Administrator mode.

## 15. PARAMETERS TABLE

### 15.1.4 Sensors:

Settings related to the sensors. The letter x represents the sensor inputs S1 to S8.

FUNCTION	DESCRIPTION	Celsius / psi				Fahrenheit / bar				
		Min	Max	Unit	Default	Min	Max	Unit	Default	
SENSORS	1.4.x.1	Pressure at 4mA	-14,5	3191,0	psi	0,0	-1,0	220,0	bar	0,0
	1.4.x.2	Pressure at 20mA	-14,5	3191,0	psi	232,0	-1,0	220,0	bar	16,0
	1.4.x.3	Pressure offset	-50,0	50,0	psi	0,0	-3,4	3,4	bar	0,0
	1.4.x.4	Temperature offset	-50,0	50,0	°C	0,0	-90,0	90,0	°F	0,0

#### 1.4.x.1 Pressure at 4mA:

Pressure value of the sensor at 4mA (Lower scale limit).



**Note:** To configure this parameter, control status must be OFF and in Administrator mode.

#### 1.4.x.2 Pressure at 20mA:

Pressure value of the sensor at 20mA (Upper scale limit).



**Note:** To configure this parameter, control status must be OFF and in Administrator mode.

#### 1.4.x.3 Pressure Offset:

Allows compensating for deviations in pressure reading.

#### 1.4.x.4 Temperature Offset:

Allows compensating for deviations in temperature reading.

### 15.1.5 Analog Outputs

Configuration of limit values for the analog outputs. The letter x represents the analog outputs A1 and A2.

FUNCTION	DESCRIPTION	Min	Max	Unit.	Standard.	
ANALOG OUTPUTS	1.5.x.1	Actuation range of the analog output	0	2	-	0
	1.5.x.2	Minimum value of the analog output	0	1.5.x.4	%	0
	1.5.x.3	Starting value of the analog output	1.5.x.3	1.5.x.4	%	0
	1.5.x.4	Maximum value of the analog output	1.5.x.3	100	%	100

#### 1.5.x.1 Actuation Range Of The Analog Output:

Defines the operating range of the output voltage. The minimum voltage value corresponds to 0% and the maximum value corresponds to 100% of the associated fan capacity.

0-0-10V

1-0-5V

2-1-5V

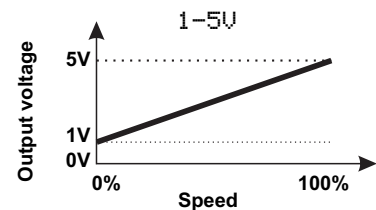
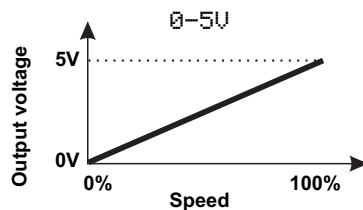
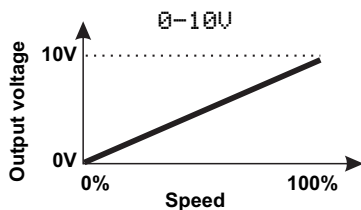

**Note:** To configure this parameter, control status must be OFF and in Administrator mode.

#### 1.5.x.2 Minimum Value of the Analog Output:

This is the minimum value that the analog output will assume when activated. This value serves to limit the minimum rotation speed of the fan.



**Note:** To configure this parameter, control status must be OFF and in Administrator mode.

#### 1.5.x.3 Starting Value of the Analog Output:

This is the value of the analog output during the starting time.

**Note:** Reserved parameter. To use this feature, use parameter 1.2.x.58 – Variable fan start-up time at maximum speed.



**Note:** To configure this parameter, control status must be OFF and in Administrator mode.

#### 1.5.x.4 Maximum value of the analog output:

It is the maximum value that the analog output will assume when it is activated. This value serves to limit the maximum rotational speed of the fan.



**Note:** To configure this parameter, control status must be OFF and in Administrator mode.

## 15. PARAMETERS TABLE

### 15.1.6 Refrigerant Fluid Curve - Point 1 to Point 20:

Allows adjusting a customized saturated refrigerant fluid curve. If you need to use a refrigerant fluid that is not included in the list, you can enter the saturation pressure and temperature values. Pressure and temperature values must be entered in ascending order from 1 to 20; that is, the values at point 2 must be higher than the values at point 1. At least 10 points must be configured for control (Point 1 to Point 10). The letter "x" represents points 1 to 20.

FLUID CURVE	FUNCTION	DESCRIPTION	Celsius / psi				Fahrenheit / bar			
			Min	Max	Unit	Default	Min	Max	Unit	Default
			1.6.x.1	Point x - Mapped curve pressure	-14,5	3191,0	psi	-14,5	-1	220,0
1.6.x.2	Point x - Mapped Curve Temperature	-50	200	°C	-50	-58	392	°F	-58	

#### 1.6.x.1 Point x - Mapped curve pressure:

Pressure value of the point.

#### 1.6.x.2 Point x - Mapped curve temperature:

Value of the point temperature.

### 15.2 System Settings:

SYSTEM	FUNCTION	DESCRIPTION	Min	Max	Unit.	Standard.
			2.1	Pressure Measurement Unit	psi	bar
2.2	Temperature Measurement Unit	Celsius	Fahrenheit	-	Celsius	
2.3	Language	Portuguese	Spanish	-	Portuguese	
2.4	Audible alarm (buzzer)	No	Yes	-	No	
2.5	Enables ECO mode for the display	No	Yes	-	Yes	
2.6	Enables <b>FG-CAP V.2</b>	No	Yes	-	No	

#### 2.1 Pressure Measurement Unit:

Pressure measurement unit used by the controller:

0- Psi

1- bar

#### 2.2 Temperature Measurement Unit:

Temperature measurement unit used by the controller:

0- Celsius

1- Fahrenheit

#### 2.3 Language:

Controller language

0- Portuguese

1- English

2- Spanish

#### 2.4 Audible alarm (buzzer):

Enables the sound alert function in case of an alarm and controller feedback.

#### 2.5 Enable ECO Mode for Display:

Enables display sleep mode. After a period of 15 minutes, the display brightness decreases, increasing its lifespan and reducing energy consumption.

#### 2.6 Enable **FG-CAP V.2**:

0- No: Does not use **FG-CAP V.2**. The use of a solenoid valve is mandatory to ensure the fluid line is closed in case of a power failure.

1- Yes: Uses **FG-CAP V.2**, which assists in closing the electronic expansion valve in case of a power failure.

For more information about **FG-CAP V.2**, refer to [item 9.1](#).



**Note:** When enabled (2.6 = Yes), upon energizing the controller, the **FG-CAP V.2** load time ( $\pm 10$ min) will be added to the initialization stage. After this time has elapsed, the instrument will perform the control.

## 15. PARAMETERS TABLE

### 15.3. Communication Settings:

The **VX-I225** features two independently configurable RS-485 communication ports for communication with Sitrad® software or supervisory systems that use the MODBUS protocol.

	FUNCTION	DESCRIPTION	Min	Max	Unit.	Standard.
COMMUNICATION	3.1	RS485-1: Protocol	Sitrad	Modbus	-	Sitrad
	3.2	RS485-1: Address	1	247	-	1
	3.3	RS485-1: Baud rate	4800	115200	-	19200
	3.4	RS485-1: Parity	0	2	-	0
	3.5	RS485-1: Stop bits	1	2	-	1
	3.6	RS485-2: Protocol	Sitrad	Modbus	-	Sitrad
	3.7	RS485-2: Address	1	247	-	1
	3.8	RS485-2: Baud rate	4800	115200	-	19200
	3.9	RS485-2: Parity	0	2	-	0
	3.10	RS485-2: Stop bits	1	2	-	1

#### 3.1 e 3.6 RS485-X/Protocol:

Communication protocol for the RS485-X port.

- 0- Sitrad
- 1- MODBUS

#### 3.2 e 3.7 RS485-X/Address:

Network address of the RS485-X port. (Available for Sitrad and MODBUS protocols).

#### 3.3 e 3.8 RS485-X/Baud Rate:

Communication data rates (Available only for the MODBUS protocol).

- 0- 4800
- 1- 9600
- 2- 19200
- 3- 38400
- 4- 57600
- 5- 115200

#### 3.4 e 3.9 RS485-X/Parity:

Parity of the communication protocol (Available only for the MODBUS protocol).

- 0- Odd
- 1- Even
- 2- No Parity

#### 3.5 and 3.10 Rs485-X/Stop bits:

Number of stop bits (Available only for the MODBUS protocol).

- 0- 1 = 1 stop bit
- 1- 2 = 2 stop bits

## 15. PARAMETERS TABLE

### 15.4 Comunicação com o Sitrad®:

A comunicação com o software Sitrad® Pro segue a seguinte estrutura de rede: Para mais informações acesse: [www.sitrad.com.br](http://www.sitrad.com.br)

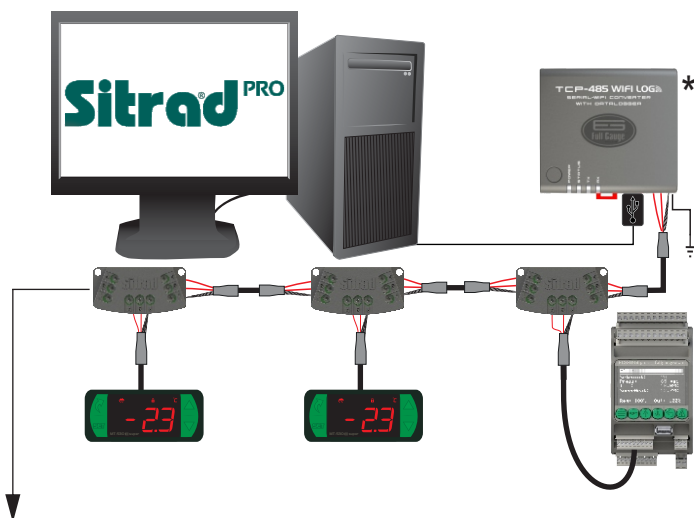

#### \* INTERFACE SERIAL RS-485

Device used to establish the connection of Full Gauge Controls instruments with Sitrad®.

Full Gauge offers different interface options, including technologies such as USB, Ethernet, Wifi, among others.

For more information, consult Full Gauge Controls.

**Sold separately.**

#### MODBUS PROTOCOL

The controller allows you to configure the RS-485 communication port for the MODBUS-RTU protocol. For more information about the implemented commands and the registration table, contact Full Gauge Controls.



#### CONNECTION BLOCK

It is used to connect more than one controller to the Interface. The wire connections must be made as follows: Terminal **A** of the controller connect to terminal **A** of the connection block, which in turn, must be connected to terminal **A** of the Interface. Repeat the procedure for terminals **B** and  $\frac{1}{2}$ , being  $\frac{1}{2}$  the cable screen.

### 15.5 Data Management:

The **VX-I225** plus features a USB port supporting communication via a pendrive, allowing management of recipes and firmware updates for the controller. Access path: **Main Menu** → **Data Management**.

	FUNCTION	DESCRIPTION
PEN-DRIVE	4.1	Export Recipe VX -> Pen Drive
	4.2	Import Recipe VX <- Pen Drive
	4.3	Firmware Update

#### 4.1 Export Recipe → VX-I225 → Pendrive (5.1):

Copies the recipe from the controller to the memory of the pendrive. The file will be stored in the VX-1225 folder and named according to the following logic:

MODEL\_AAMDD\_HHMMSS.rec, where:

MODEL = product model, AA = year, MM = month, DD = day, HH = hour, MM = minute, SS = second.

**Example:** A recipe exported from a VX-1225 on 02/08/2019 at 13:30:00 will be named VX-1225\_190802\_133000.rec.

#### 4.2 Import Recipe VX-I225 Pendrive (5.1):

Copies the recipe from a pendrive to the memory of the controller.

The **VX-I225** looks for the recipe within the VX-1225 folder. The recipe name can have a maximum of 32 characters, including the extension (.rec).

**Note:** The VX-1225 folder must contain a maximum of 32 recipe files.

#### 4.3 Firmware Update (5.3):

Updates the firmware of the controller.

The file must be within the VX-1225 folder and its name can have a maximum of 32 characters, including the extension (.ffg).

**Note 1:** The folder must contain a maximum of 32 firmware files.

**Note 2:** Changing some functions, such as recipe download, requires the control to be turned off.

### 15.6 Restore Factory Settings:

FUNÇÃO	DESCRIÇÃO
5	Restore Factory Settings

#### Restore Factory Settings:

Resets all settings and parameters to factory default values. Access path:

**Main Menu** → **5 Restore Factory Settings**.

## 16. PID

The PID controller is made up of a combination of three control actions: Proportional action (P), Integral action (I) and Derivative action (D). Each action receives a weighting (adjustable via parameters) which represents a gain or adjustment time. This enables the PID to perform better when controlling the process. Any control action is limited by the quality and capacity of the existing actuators in the process.

**P - Proportional gain (Kp)** - The use of proportional action in a control system enables the difference (error) between the desired output (reference, setpoint) and the current value of the process, to be reduced. The proportional gain speeds up process's response, however, the increased gains can result in control oscillating.

**I - Integral time (Ti)** - The integral action has an energy storage function, which allows it to remove the error between the reference and the output. It accumulates the error at a " Ti " rate, and attempts to reduce it to zero. Low Ti values can cause the control to oscillate, however, long Ti times tend to slow down the process. Integral action must not be used on its own.

**D - Derivative time (Td)** - The use of derivative action enables the process's response time to be increased and reduces oscillation, as it tries to anticipate the process's behavior. Low Td values tend to reduce oscillation

SUMMARY TABLE - GENERAL GUIDANCE*			
PID PARAMETER	OVERSHOOT (peak)	STABILIZATION TIME (delay in stabilizing the controller)	ERROR (The difference between the setpoint and the sensor)
Increase KP**	Increase	Little Effect	Reduce
Reduce Ti	Increase	Increase	Null error
Increase Td	Reduce	Reduce	No effect

*Note: Change the parameters individually, check the response and then modify another parameter. Proceed with caution, use Sitrad® Pro to monitor the behavior of the process, analyze and modify the control parameters.*

*\* This guide is widely applied in the technical literature on PID controllers, however processes with latency in their response may differ from the indication in the table. The technician responsible for the process must correct small deviations manually.*

*\*\* In specific applications, the behavior can be opposite to that indicated.*



## 17. ALARMS

The **VX-I225** controller features an alarm system that allows configuring alarms for protection or display only. All alarm settings are linked to the operating modes.

When an alarm occurs, an audible warning will be triggered and will remain active until one of the following conditions is met:

- The alarm condition ceases; The audible warning is muted (by pressing the  key for 5 seconds).
- If the audible warning is not desired, it must be disabled in the **Main Menu** → **2. System Configuration** → **4. Audible Warning (Buzzer)**.

### 17.1 Alarm Display:

A single press of the  key displays the active alarms; pressing it again displays the Alarm History screen. Up to 99 records are stored in each of these three lists, and it is possible to navigate between records using the  and  keys.

When the list is full, new alarms will overwrite the oldest alarm records. Each alarm record contains information about the reason for the alarm, the start time, and the end time of the occurrence.

To delete alarm records, access the Alarm History list, press and hold the  key for 3 seconds, and confirm the request.

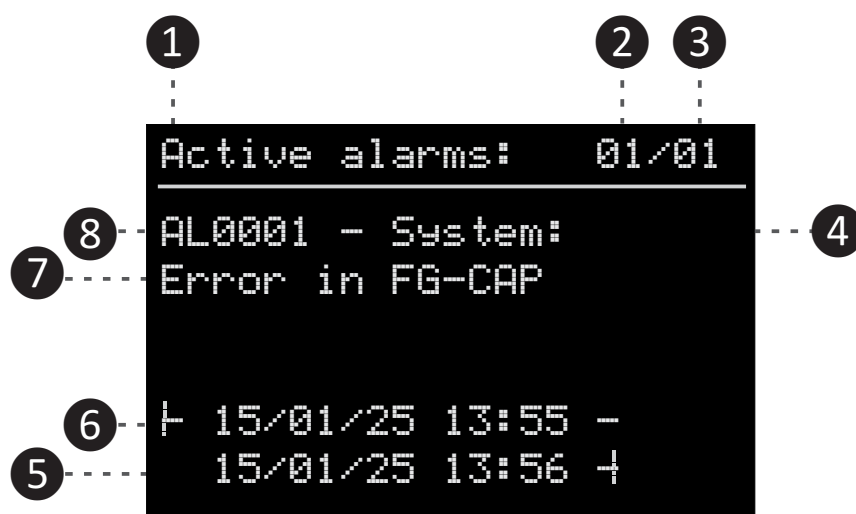

- 1** – Alarm list in display:  
**Active alarms:** Alarms that are active, in alarm condition  
**Alarm history:** Records all alarms that are no longer active or in reset condition.

- 2** – Record number of the list being displayed. Record 1 is always the most recent.

- 3** – Number of records in each alarm list.

- 4** – Alarm origin.

- 5** – Time when the alarm stopped occurring.  
If the alarm stop time has an asterisk (\*), it means that the controller was powered off while the alarms were active, and it is not possible to determine the exact time when the alarm stopped occurring. In this case, the time when the controller was powered on after this occurrence is displayed.

- 6** – Start time of the alarm occurrence.

- 7** – Alarm description.

- 8** – Alarm identifier code. See alarm table.

## 17. ALARMS

### 17.2 Reset in cases of LoSH, LOP, and MOP alarms:

The compressor shutdown in **ASHL**, **ALOP**, and **AMOP** alarms depends on parameter 1.2.x.76. When configured to shut down in any of these alarms, the compressor will only be switched off after the validation time defined in 1.2.x.75, and will remain off for the time configured in 1.2.x.77.

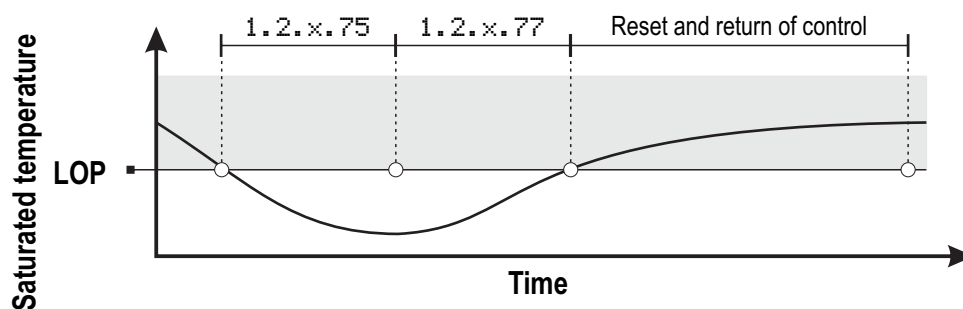
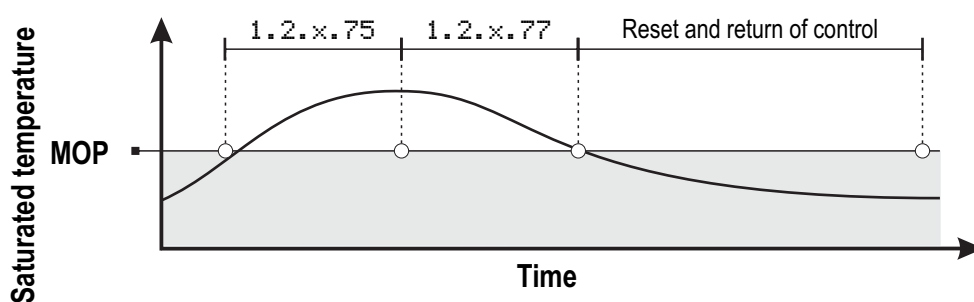
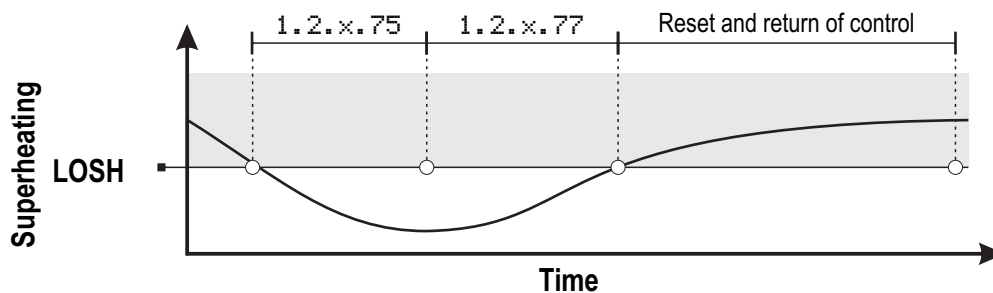

When set in parameter 1.2.x.76, the control will be suspended for the duration specified in 1.2.x.77.

#### Legend:

- 1.2.x.75 - Validation time for protection alarms (LoSH, LOP, MOP).
- 1.2.x.76 - Compressor state in case of protection alarms (ASHL, ALOP, AMOP).
- 1.2.x.77 - Time for compressor return after protection alarms (ALoSH, ALOP, AMOP).



**Note:** This process repeats until the saturated temperature or superheating stabilizes.

## 17. ALARMS

### 17.3 Alarm tables

#### 17.3.1 System alarms:

The table below describes the effects of each alarm related to the controller system.

Alarme	Descrição	Efeito
AL0001	PPP	Reset function values.
AL0002	ECAL	Contact Full Gauge.
AL0003	Clock not set	Clock not programmed. Functions linked to the clock are disabled, adjust the clock.
AL0004	Error in <b>FG-CAP</b>	<b>FG-CAP V.2:</b> ultracapacitors did not reach the required energy charge for the safe operation of the system. The process control remains off. Check the correct operation of the power supply and electrical connections.

#### 17.3.2 Operational alarms:

The table below describes the effects of each alarm related to the operation of the controller. The x represents a group of parameters, 1 or 2.

Alarme	Descrição	Efeito
AL0x01	High temperature alarm - Cold room x	Indicator alarm - High temperature on the ambient temperature sensor.
AL0x02	Low temperature alarm - Cold room x	Indicator alarm - Low temperature on the ambient temperature sensor.
AL0x03	Compressor running alarm without reaching setpoint	Indicative alarm.
AL0x04	Error in ambient temperature sensor - Cold room x	Failure in the ambient temperature sensor. The control continues with pre-programmed compressor operation times.
AL0x05	Error in evaporator temperature sensor x	Failure in the evaporator temperature sensor. Defrost will only occur based on the maximum time without defrost.
AL0x06	Error in suction temperature sensor x	Failure in the suction temperature sensor. The control assumes the behavior defined in parameter 1.2.x.78. Control action in case of overheating sensor errors.
AL0x07	Error in suction pressure transducer x	Failure in the suction pressure sensor. The control assumes the behavior defined in parameter 1.2.x.78. Control action in case of overheating sensor errors.
AL0x08	Error in evaporator superheating calculation x	Sensor failure prevents the overheating calculation. The control assumes the behavior defined in parameter 1.2.x.78. Control action in case of overheating sensor errors.
AL0x09	Low superheating alarm (ASHL)	Turns off (if enabled) the control for system protection.
AL0x10	Low evaporation temperature alarm (ALOP)	Turns off (if enabled) the control for system protection.
AL0x11	High evaporation temperature alarm (AMOP)	Turns off (if enabled) the control for system protection.
AL0x12	Error in valve activation	It turns off the control. After this error occurs, it is necessary to reset the controller to resume refrigeration control.
AL0x13	Open door alarm	Indicative alarm.
AL0x14	External alarm	Indicative alarm.
AL0x15	External failure	Turns off the control. External failure to the controller.
AL0x16	Reference temperature sensor error	Indicative Alarm – Reference Temperature Sensor Failure

# 18. IMPORTANT

According to IEC 60364 standard chapters:

- 1: Install surge protectors in the supply
- 2: Sensor and serial communication cables can be assembled, but not in the same conduit through which power supply and charge actuation pass
- 3: Install transient suppressors (RC filter) in parallel to the charges, to increase the life span of relays.

Wiring schematics for suppressors in contactors

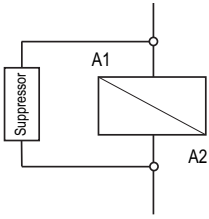

A1 and A2 are the contactor coil terminals

Wiring schematics for suppressors on charges with direct actuation

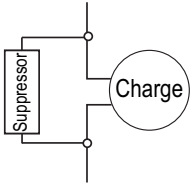

For light direct delivery maximum current Specified.

Full Gauge Controls makes suppressors available for sale

# 19. WARRANTY

**ENVIRONMENTAL INFORMATION**

**Packing:**  
The materials used in the packaging of Full Gauge products are 100% recyclable. Try to dispose of it through specialized recycling agents.

**Product:**  
The components used in Full Gauge controllers can be recycled and reused if disassembled by specialized companies.

**Disposal:**  
Do not burn or dispose of controllers that reach the end of their life span in household trash. Observe the existing effective legislation in your region regarding the disposal of electronic waste. In case of any doubts, contact Full Gauge Controls.

WARRANTY TERM - FULL GAUGE CONTROLS

The products manufactured by Full Gauge Controls, from May 2005, have a warranty period of 10 (ten) years directly with the factory and 01 (one) year with accredited resellers/dealers, from the date of the consigned sale on the invoice. After this year with resellers, the warranty will continue to be effective if the instrument is sent directly to Full Gauge Controls. This period is valid for the Brazilian market. Other countries have a 2 (two) year warranty. The products are guaranteed in case of manufacturing failure that makes them improper or unsuitable for the applications for which they are intended. The warranty is limited to the maintenance of instruments manufactured by Full Gauge Controls, disregarding other types of expenses, such as indemnification due to damages caused to other equipment.

**EXCEPTIONS TO WARRANTY**

The Warranty does not cover transport and / or insurance costs for sending products with indications of defect or malfunction to Technical Assistance. The following events are also not covered: natural wear of parts, external damage caused by falls or improper packaging of products.

**LOSS OF WARRANTY**

The product will automatically lose its warranty if:

- The instructions for use and assembly in the technical description and the installation procedures present in Standard IEC 60364 are not observed;
- It is subjected to conditions beyond the limits specified in its technical description;
- It is violated or repaired by a person who is not part of Full Gauge's technical team;
- The damage is caused by a fall, blow and / or impact, water infiltration, overload and / or atmospheric discharge.

**WARRANTY USE**

To be covered and benefit from the guarantee, the customer must send the product properly packed, together with the corresponding purchase invoice, to Full Gauge Controls. Shipping costs for products are at customer's costs. It is also necessary to send as much information as possible regarding the detected defect, thus making it possible to streamline the analysis, testing and service.

These processes and eventual product maintenance will only be carried out by Full Gauge Controls' Technical Assistance, at the Company's headquarters- Rua Júlio de Castilhos, 250, CEP 92120-030 - Canoas - Rio Grande do Sul - Brazil.