



TC-970E Log+ECO Ver.04

TC-970E Log+ECO Faston Ver.04

DIGITAL FREEZING CONTROLLER

EVOLUTION



TC970ELOG+ECO04-04T-19979-2605

Have this manual in the palm of your hand through the FG Finder app.

- Variable speed fan
- Quick coupling connection
- Variable compressor
- Switch Off Control Functions
- Programming in Series
- Protection degree
- HACCP Function
- Fast Freezing
- Datalogger
- Monitoring System
- Modbus Protocol



1. DESCRIPTION

The **TC970E Log + ECO** and **TC970E Log + ECO Faston** are electronic controllers for refrigeration of freezers, beverage displays, islands and refrigerated counters. These controllers can activate the refrigeration, defrost, fan and lighting system, and have up to two digital inputs and two main sensors, one for room temperature and another that, fixed to the evaporator, controls the end of the defrost and the return of the fans. They also allow the inclusion of a third sensor, which can be used to activate the economic setpoint, control the condenser or in the second evaporator and a fourth sensor for various monitoring.

The +ECO line includes the control of VCC - Variable Capacity Compressors and VSF - Variable Speed Fans. The +ECO controllers provide a series of benefits to the cooling system, such as: reduced energy consumption, less temperature fluctuation, greater speed in reaching the desired temperature. From the configuration of its parameters it is possible to make the controller compatible with the main brands of variable compressors on the market. For better use of energy, ventilation can be controlled during the compressor off cycle and use Smooth Defrost, a defrosting technique that reduces the final temperature of the electrical resistance and the amount of heat emitted.

The room temperature control has a normal setpoint and an economy setpoint, in addition to the fast freezing functionality, alarm functions and specific keys to activate / deactivate the economy mode and turn the lamp on/off.

Your relays are activated with Zero-Cross technology. The use of this technology allows for smoother and more efficient load switching, reducing noise, interference, and component wear.

They have a serial communication output for integration with Sitrad, an internal real-time clock that allows the programming of defrost and lighting events, an intelligent function blocking system, an internal buzzer, control of external pressure switches, an hour meter for compressor maintenance, digital filter to simulate a moment of mass in the room temperature sensor, shutdown mode of control functions and internal memory (datalogger) for storing the temperature value in periods of time determined by the user, temperature variation and the output states. They also allow the monitoring of HACCP - Hazard Analysis and Critical Control Points through records in the memory of the temperature alarm, open door and power failure controllers.

The **TC970E Log + ECO** and **TC970E Log + ECO Faston** allows you to configure the RS-485 communication port for the MODBUS-RTU protocol. For more information about the implemented commands and the registration table, contact Full Gauge Controls. Product conforming to UL Inc. (United States and Canada)(*).

The **TC970E Log + ECO** and **TC970E Log + ECO Faston** allows you to configure the RS-485 communication port for the MODBUS-RTU protocol. For more information about the implemented commands and the registration table, contact Full Gauge Controls. Product conforming to UL Inc. (United States and Canada)(*).

2. SAFETY RECOMMENDATIONS

- Make sure you know the correct way to install the controller;
- Make sure that the power supply is turned off and that it is not going to turn on during the installation of the controller;
- Read this manual before installing and using the controller;
- Use appropriate Personal Protective Equipment (PPE);
- Where it will be used in areas subject to splashing water, such as refrigerated counters, install the protective film that comes with the controller;
- For protection under more critical conditions, we recommend the Ecase cover, which we offer as an options (sold separately);
- The installation procedures must be carried out by a competent engineer, with regard to current regulations.

3. APPLICATIONS

- Beverage displays;
- Frozen counters;
- Chambers;
- Refrigerated trucks.

4. TECHNICAL SPECIFICATIONS

Power Supply	TC-970E Log + Eco: 90~240Vac ± 10%(**) (50/60Hz)(*) TC-970EL Log + Eco: 12 ou 24Vac/dc (***) + 10%(**) TC-970E Log + Eco Faston: 90~240Vac ± 10%(**) (50/60Hz)(*) TC-970EL + Eco Faston: 12 ou 24Vac/dc (***) + 10%(**)
Control temperature	-50 to 105°C / -58 to 221°F
Operating temperature	-20 to 60°C / -4 to 140°F
Temperature resolution	0,1°C / 0,1°F
Average Power Consumption 4VA	± 4VA
Digital input	Configurable dry contact type
Clock (RTC)	Energy backup: CR1220 battery, Time keeping for up to 10 years, Accuracy: ± 6 minutes/year
Frequency output	10Vcc (± 10%) 50mA max. 0...300Hz (duty-cycle = 50%)
Analog output	0~10Vdc (10 mA max.)
Operating humidity	10 a 90% UR (without condensation)
Protection degree	IP 65 (front)
Maximum Sizes (mm)	76 x 34 x 97 mm / 2,99" x 1,33" x 3,82" (WxHxD)
Cutout dimensions (mm)	71±0,5 mm(2,79"±0,02") x 29±0,5 mm(1,14"±0,02")
Output capacity	
COMP	120-240 Vac, 12A Resistive, 100k cycles 120-240Vac, 8A General Use, 100k cycles 240 Vac, 1HP, 100k cycles 120 Vac, 1/2HP, 100k cycles
DEFR	120-240 Vac, 5A Resistive
FAN	240 Vac, 1/8 HP 120 Vac, 1/10 HP
AUX	240 Vac, 1/8 HP 120 Vac, 1/10 HP 120-240 Vac 5W General Use

(*) The model with 90~240 Vac power supply is UL certified.
(**) Permissible variation in relation to the rated voltage
(***) The Zero Cross drive does not apply to 12 Vac/dc and 24 Vac/dc controllers.
(****) Outputs triggered at the zero-crossing point of the power grid (Zero Cross).

5. INDICATIONS AND KEYS

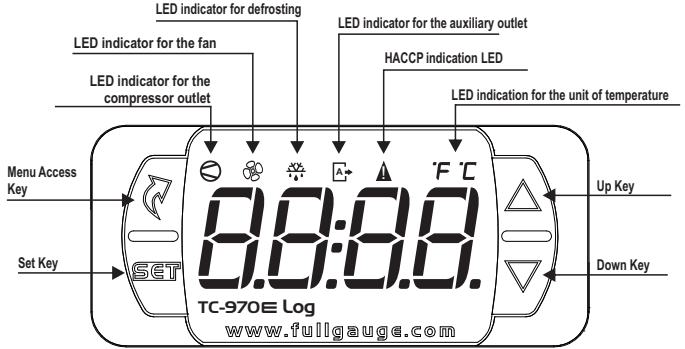

6. INSTALLATION - PANEL AND ELECTRICAL CONNECTIONS

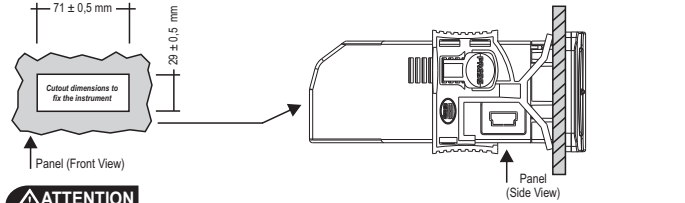

ATTENTION
FOR INSTALLATIONS THAT REQUIRE LIQUID SEALING, THE CUT OUT FOR INSTALLING THE CONTROLLER MUST BE A MAXIMUM OF 70.5x29mm. THE SIDE LOCKS MUST BE FIXED IN A WAY THAT IT PRESSES THE RUBBER SEAL AVOIDING INFILTRATION BETWEEN THE CUT-OUT AND THE CONTROLLER.

7. WIRING DIAGRAM

Image I - 90~240Vac Connection

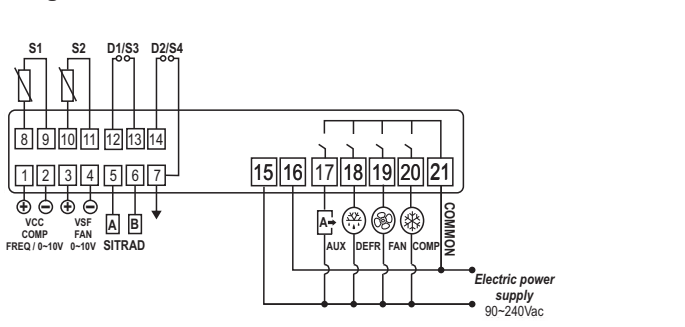

Image II - 12 Vac/dc Connection

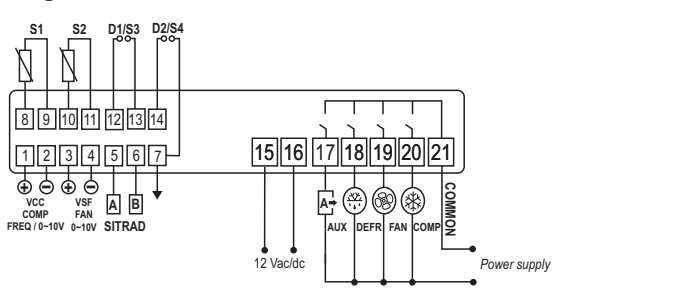
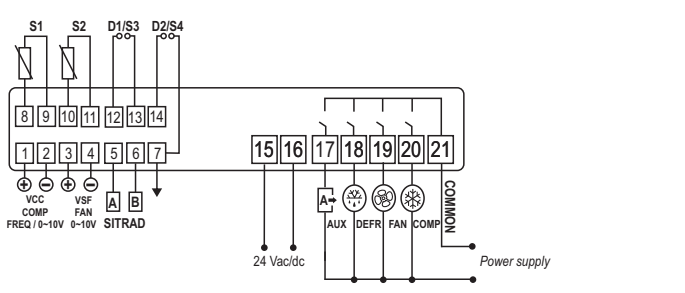

Image III - 24 Vac/dc Connection



The **S1** sensor must be in the environment.
The **S2** sensor must be fixed to the evaporator using a metal clamp.

Key: To the terminal of the connection block

NEW CONNECTION SYSTEM (QUICK COUPLING): PLUGGABLE AND QUICK PUSH-IN

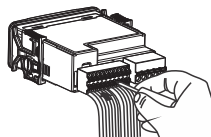
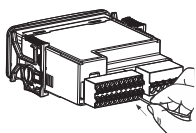

PUSH-IN CONNECTION:

- Hold the wire close to its end and insert it into the required opening
- If necessary, press the button to help make the connection.
- Ferrule type terminals can be used. For the signal connections, the ferrule must be at least 12mm. In power connectors the pin must be at least 7mm.

NOTE 1 - Signal Connectors:

- In connectors 1 to 14, the wire gauge must be between 0.2 and 1.5mm² (26 and 16AWG).

NOTE 2 - Power Connectors:

- In connectors 15 to 21, the wire gauge must be between 0.2 and 2.5mm² (26 and 12AWG).

PUSH-IN DISCONNECTION:
- To disconnect the wire, press the button and remove it.

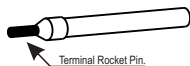
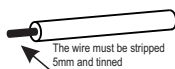

7.1. Connecting the temperature sensors

- Connect sensor wires S1 to terminals "8 and 9", sensor wires S2 to terminals "10 and 11" and sensor wires S3 to terminals "12 and 13" and sensor wires S4 to terminals "14 and 7": polarity is indifferent.
- The length of the sensor cables can be increased by the user themselves by up to 200 meters, using a 2x24 AWG PP cable.

7.2. Recommendations from NBR5410 and IEC60364 standards

- Install surge protectors to the controller's power supply;
- Install transient suppressors - suppressor filter (type RC) - in the circuit to increase the working life of the controller's relay;
- The sensor cables can be together, but not in the same conduit as the power supply for the controller or the loads.

8. FIXATION PROCEDURE

- Cut out the panel plate (Diagram 5 - item 15) where the controller is going to be installed, to a size where X = 71±0,5 mm and Y = 29±0,5 mm;
- Remove the side clasps (Diagram 6 - item 15): to do this, press on the elliptical central part (with the Full Gauge Controls) and slide the clasps back;
- Pass the wires through the opening (Diagram 7 - item 15) and install the electrics as described in item 7;
- Insert the controller into the opening made in the panel, from the outside;
- Replace the clasps and move them until they are pressed against the panel, securing the controller to the housing (see arrow in Diagram 6 - item 15);
- Adjust the parameters as described in item 9.

⚠ WARNING: Where the installation needs to be sealed tight against liquids, the opening for the controller must be more than 70.5x29mm. The side clasps must be secured in such a way as to create a tight rubber seal that prevents any liquids entering the opening and the controller.

Protective Film - Diagram 9 (item 15)

This protects the controller when it is installed somewhere subject

⚠ IMPORTANT: Only apply it after you have finished making the electrical connections.

- Pull the side clasps back (Diagram 6 - item 15);
- Remove the protective film from the adhesive vinyl strip;
- Apply the film to the entire upper part, folding the flaps, as indicated by the arrows - Diagram 9 (item 15);
- Replace the clasps.

Note: The film is transparent, so that the electrical layout of the device can be seen.

9. OPERATIONS

9.1 Quick Access Menu Map

Press the key (short press) to navigate through the menu functions. Each press will display the next function in the list. To confirm press the (short press). The menu function map is below:

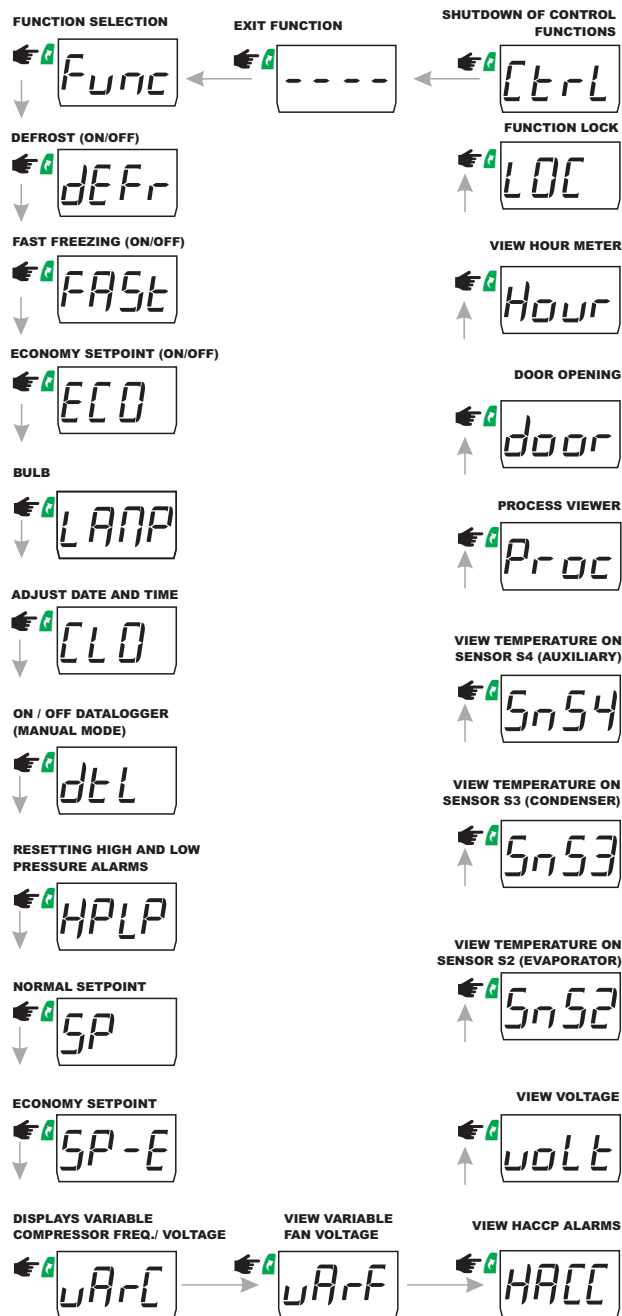

9.2 List of Key Functions

The keys listed act as shortcuts for the following functions:

	Short press: View date and time
	Short press: Stop the audible alarm
	Press for 2 seconds: Setpoint adjustment
	Short press: Activate / Deactivate economy mode
	Press for 2 seconds: Display of minimum and maximum temperatures
	Press for 2 seconds: When displaying temperature, compressor hour meter or door opening number records, clears history
	Press for 4 seconds: Manual defrost
	Short press: Turn on / off the lamp
	Press for 4 seconds: View process steps, temperature on sensors S2 / S3 / S4 and current setpoint
	Short press: enters the easy menu.
	Press for 4 seconds: shutdown of control functions
	Press for 2 seconds: Enter the HACCP menu
	Short press: Enter menu selection

9.3 Basic operation

9.3.1 Desired Temperature Adjustment (setpoint)

To enter the setpoint adjustment menu, press **⏏** for 2 seconds. The message **[5P]** will appear on the display, followed by the value for adjusting the normal setpoint. Use the **▲** or **▼** keys to modify the value and confirm by pressing **⏏**. Then the message indicating **[5P-E]** the economic setpoint adjustment will be displayed. Again, use the **▲** or **▼** keys to modify the value and confirm by pressing **⏏**. Finally, the indication **[---]** signals the completion of the configuration. Setpoints can also be changed individually in the access menu.

9.3.2 Economic setpoint (SPE)

[5P-E] provides greater savings to the system by using more flexible parameters for temperature control.

When it is active, the message **[EE]** starts to be displayed alternating with the temperature and the other messages.

Economy mode can be activated or deactivated using the commands:

Function	Command	Action
F09/F10/F11	Time to activate	Activate
F12	S3-S1 temperature difference to activate	Keeps active
F13	S3-S1 temperature difference to disable	Deactivate
F14	Maximum temperature in economic mode	Deactivate
F14	Maximum temperature in economic mode = 0 (Off)	Not dependent on time, only deactivated when door is opened
F60 = 1 or 2 F61 = 1 or 2	Indicates door is open (digital input)	Keeps it disabled
F60 = 7 or 8 F61 = 7 or 8	External key (digital input)	Activate/Deactivate
F65	Time to activate after door is closed	Activate
-	Action via the easy menu ([EE])	Activate/Deactivate
-	Action by the ▲ key (short press)	Activate/Deactivate
-	Error measuring room temperature (S1)	Keeps it disabled
-	On switching on the instrument	Deactivate
-	Fast Freezing	Deactivate

9.3.3 Manual defrost

The defrost process can be activated / deactivated manually through the easy menu in the **[EEF]** option or by pressing the **▲** key for 4 seconds or using the external key connected to the digital input. Activation or deactivation is indicated by the message **[EEF]** **[0n]** or **[EEF]** **[0FF]**, respectively.

9.3.4 How to determine when defrosting is complete using the temperature

- Set the condition for starting defrosting as based on time, **[F19] = 1**;
- Reset the functions related to the end of defrosting to their maximum value:
 - Refrigeration time (interval between defrosting periods) **[F20] = 9999min**;
 - Temperature of the Evaporator to finish the defrost **[F39] = 105°C / 221°F**;
 - Maximum time on defrost (for safety) **[F41] = 999min**.
- Wait a while until a layer of ice has formed on the evaporator;
- Defrost manually (using the key **▲** advance to **[EEF]** and press **⏏** or press the **▲** key for 4 seconds);
- Visually monitor the melting;
- Wait until all the ice on the evaporator has melted to determine when the defrosting is over;
- With the defrost completed, check the temperature in the evaporator (S2) using the **▼** key (see item 9.3.13);
- Using the reading for S2, adjust the temperature to end the defrosting;
 - Evaporator temperature to end defrost **[F39] = Temp S2**.
- As a safety measure, reset the maximum defrost duration, according to the type of defrosting set;
Example:
 - Electric defrost (by resistors) **[F41] = 45 min**;
 - Hot gas defrost **[F41] = 20min**.
- Finally, adjust the refrigeration time (Interval between defrosts) **[F20]** to the desired value.

9.3.5 Defrost with two evaporators

With S3 configured for the 2nd evaporator sensor **[F60]**, the FAN output gives rise to the control of the second resistor. Defrost always starts with both outputs activated. The resistors are turned off individually as their evaporators reach the temperature for defrosting. With both outputs off or after the maximum defrost time has elapsed, the draining process starts.

Note 1: With these settings, all FAN output functionalities are disregarded, including the Fan Delay process.

Note 2: Defrosting with two evaporators using the FAN output does not prevent the use of the variable speed fan (VSF). In this case, the fan speed is calculated in relation to the sensor with the highest temperature (to limit the inflow of hot air).

9.3.6 Fast Freezing

In fast freezing mode, the refrigeration output is permanently on and therefore the refrigeration or freezing process is accelerated. This operating mode can be activated or deactivated in the easy menu, in the **[F55E]** option or through an external switch connected to the digital input. It can also be deactivated automatically by temperature (**[F15]**) or by time (**[F16]**). While fast freezing is on, the connected compressor display will flash rapidly and defrosting will continue. If, on activating the fast freezing mode, the controller identifies that there is a defrost cycle programmed to start during this period of time, the defrost will be run first and then it will go into fast freezing mode.

9.3.7 Turning the lamp on/off

Through the menu facilitated in the option **[LAMP]** or by pressing the key **▼** (short press) it is possible to turn the lamp on/off manually if the AUX output is configured as a lamp (**[F89] = 1**) and the defrosting of the tray is not configured to use the AUX output (**[F43] = 2**)

Note: When switching on the lamp manually, the time for when the lamp will be switched off after the door is closed **[F64]** will be reset.

9.3.8 Adjust the date and time

The date and time can be adjusted using option **[CLD]** from the access menu. This option is accessed with the **▲** key (Flatec) and confirmed with the **▼** key.

In the date and time setting mode, use the keys **▲** or **▼** to change the value and, when ready, press **⏏** to memorize the configured value. If the date entered is invalid, the message **[ECLD]** will appear on the display.

9.3.9 View current time and dates

By briefly pressing the **▼** key (short press) you can view the date and time set on the controller. The current day (**[---d]**), month (**[---M]**), year (**[---Y]**), day of the week (**[dRdY-]**), hour and minutes will be shown in sequence on the display (**[00:00]**).

Note: The controller leaves the factory with the clock disabled. To enable it follow the directions in item 9.3.8

Example: **[dRdY]** equals Sunday.

9.3.10 Manual activation of the datalogger

Manual activation of the internal record of temperature values and status of the control outputs (Datalogger) is performed through the facilitated menu in the option **[dEL]**. The message **[dEL]** will be displayed followed by the message **[0n]** for when the datalogger is activated or **[0FF]** for when it is deactivated.

Note: For correct operation of the datalogger it is necessary to adjust the clock. See item 9.3.8

9.3.11 Function Lock

The function lock provides more security when using this device. When it is enabled the normal and economic setpoints and other parameters can be viewed, but are not able to be changed (**[F144] = 2**) or you can just lock the device against changes to the control functions but allow the normal and economic setpoints to be amendable (**[F144] = 1**). To lock the functions, access the option **[L0E]** in the easy menu using the key **▲** (Flatec) and confirm by pressing the **▼** key. The message **[0n]** will be displayed if the lock is disabled. Now press and hold the **▼** key for the time configured for this function **[F145]**.

Activation will be indicated by the message **[L0E]** **[0n]** and will only occur if function **[F144]** is set to 1 or 2. To deactivate the lock, turn off the controller and turn it on again with the **▼** key pressed. Keep the key pressed until the message **[L0E]** **[0FF]** indicates that it has been unlocked (10 seconds).

Note: The date and time adjustment will always be enabled, regardless of the values of **[F144]** and **[F145]**.

9.3.12 Shutdown of Control Functions

Turning off control functions allows the controller to operate only as a temperature indicator, keeping the control outputs and alarms off. The use of this feature is enabled or not by the Shutdown of Control Functions option **[F146]**. When enabled, the control and alarm functions are turned off (**[L0EL]** **[0FF]**) or turned on (**[L0EL]** **[0n]**) using the menu provided by the option **[L0EL]**. When the control functions are turned off, the message **[0FF]** will be displayed, alternating with the temperature and other messages. It is also possible to switch off and on the control functions by pressing the **▲** key for 5 seconds.

9.3.13 Process stage, elapsed time, temperature on sensors S2/S3/S4 and current setpoint

The controller's operating status can be viewed by pressing the **▼** key (4 seconds). A sequence of messages will be displayed indicating the current process, the time (hh:mm) already elapsed in this stage and the temperatures in sensors S2, S3, S4 and the current setpoint (normal or economic). If any sensor is disabled, its measurement will not be displayed.

Process stages:

- [dEL]** - Initial Delay (delay in starting up the instrument);
- [rEEr]** - Refrigeration;
- [Hot]** - Heating;
- [PrE]** - Pre-Defrost;
- [dEEr]** - Defrost;
- [dRA]** - Drainage;
- [FAn]** - Fan-delay (delay caused by the fan);
- [dEEd]** - Defrost in delay (combined defrost);
- [0FF]** - Control functions off.

9.3.14 View the number of door openings

The number of door openings can be viewed by pressing the **▲** (short press), until the message **[d00r]** appears, then the number of door openings will be displayed.

To reset the number of door openings to zero, keep the **▲** key pressed while viewing until the message **[r5EE]** appears.

9.3.15 View variable compressor output frequency / voltage

The output frequency / voltage applied to the variable compressor can be viewed by pressing the key **▲** until the message **[vRrC]** appears (see map in item 9.1).

9.3.16 View variable fan output voltage

The output voltage applied to the variable speed fan can be viewed by pressing the key **▲** until the message **[vRrF]** appears (see map in item 9.1).

9.3.17 Hour meter

The hour meter indicates the number of hours worked by the compressor. The hour meter is displayed via the easy menu (**▲**) in the **[HOUR]** option and the compressor's working time is displayed in hours.

It is possible to configure the maximum operating time of the compressor through the **[F103]** function. When the number of hours of compressor running reaches the value configured in this function, an alert will appear on the display (**[RnRn]**), indicating that maintenance must be carried out. To turn off the alert or reset the hour meter counter, access the **[HOUR]** option in the easy menu **▲**, press **⏏** and while the compressor on time is showing, press **▲** until the message **[r5EE]** appears.

9.3.18 Record of minimum and maximum temperatures

Pressing the **▲** key for 2 seconds during the temperature display, the message **[rE9]** will appear, followed by the minimum and maximum temperatures recorded.

Note: If you press the **▲** key while displaying the records, the values will be reset and the message **[r5EE]** will be displayed.

9.3.19 Unit Selection

To select the temperature unit the instrument will operate on, press simultaneously **▲** and **▼** during temperature display, enter **[C0dE]** option with access code **[231]** and press **↵** key. The select the desired unit **[0C]** or **[0F]** using the keys **▲** or **▼**, to confirm press **↵**.

Note: Whenever the units are changed, the function settings revert to the factory value and will therefore need to be reset.

9.4 Advanced Operations

9.4.1 Access to the main menu

The main menu can be accessed via the quick menu **[Func]** option or by pressing **▲** and **▼** (short press) simultaneously during the temperature display.

The following options will be displayed:

- [C0dE]** - Access code input;
- [Func]** - Changing the parameters;
- [Log]** - Datalogger configuration;
- [LT0]** - Date and time adjustment;
- [HAcc]** - Visualization of HACCP alarms.

9.4.2 Access code

To allow changing the parameters or setting the clock, enter the **[C0dE]** option by pressing **↵** (short press) and using the keys **▲** or **▼** enter the access code 123 (one hundred and twenty three), confirm with **↵**.

9.4.3 Amending the parameters of the controller

Within the main menu, select the option **[Func]** and select the desired function, using the **▲** or **▼** keys. After selecting the function, press the **↵** key (short press) to view its value. Use the **▲** or **▼** keys to change the value and, when ready, press **↵** to memorize the set value and return to the function menu. To exit the menu and return to normal operation (temperature indication) press **↵** (long press) until **[---]** appears.

9.4.4 Internal datalogger

Datalogger configuration functions are available in the **[Log]** menu.

With the datalogger enabled **[F123]** it is possible to make records in the controller's internal memory. These records can be configured to be performed at time intervals **[F130]**, by the variation of room temperature S1 **[F131]** and/or by the variation in the state of the digital input or outputs **[F132]**. Enabling alarms also performs log recording. The information contained in a record is: temperature of sensors S1, S2, S3 (if enabled) and S4 (if enabled), status of the control outputs, status of the door (if digital input configured as a door contact), triggered alarms, record creation date and time.

Note: No records are made in the datalogger when the clock is not set.

9.4.5 Adjust the date and time

Within the main menu select the **[LT0]** option, if the access code **[123]** was entered correctly, the controller enters the date and time setting mode. Use the **▲** or **▼** keys to change the value and, when ready, press **↵** to memorize the set value. If the date entered is invalid, the message **[ECLD]** will appear on the display. It is also possible to adjust the date and time through the easy menu (see item 9.3.8). In this case, it is not necessary to enter the access code. minimum temperature value measured during the alarm.

9.4.6 HACCP

This controller assists the management systems of the food industries, allowing the monitoring of critical points required by the HACCP (Hazard Analysis and Critical Control Points) regulation. Up to 24 records of the following types are stored: high temperature, low temperature, open door alarm and power failure.

High temperature alarm **[ALH]**

When, during operation, a temperature is identified above the value set in **[F127]** (HACCP - High room temperature alarm), remaining above this temperature for a time longer than the time set in **[F100]**, a record is created - **[ALH]** type.

In this case, the information stored is: date and time of the start of the alarm, duration of the alarm and maximum temperature measured during the alarm.

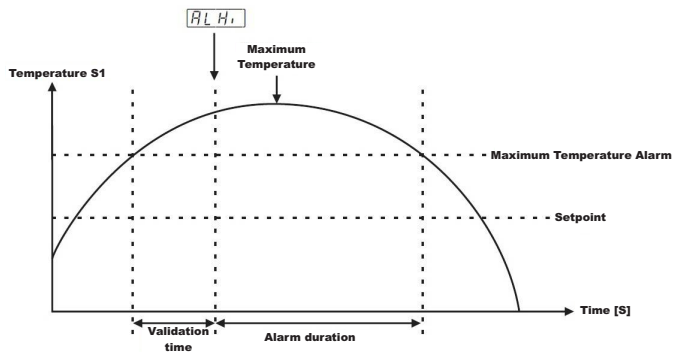

Low temperature alarm **[ALL0]**

When, during operation, a temperature lower than the value set in **[F126]** is identified (HACCP - Low temperature alarm), remaining below this temperature for a time longer than the time set in **[F100]** (HACCP - Alarm inhibit time), a record of type **[ALL0]** is created.

In this case, the information stored is: date and time of the start of the alarm, duration of the alarm and minimum temperature value measured during the alarm.

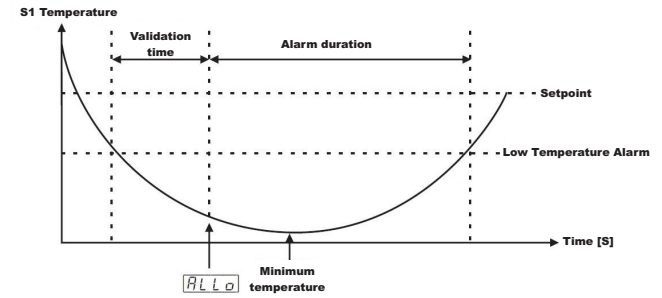

Digital input alarm **[ALIn]**

When the open door alarm is enabled and activated, a **[ALIn]** recorded will be made. In this case, the information stored is: date and time of the start of the alarm, duration of the alarm and maximum temperature measured during the alarm.

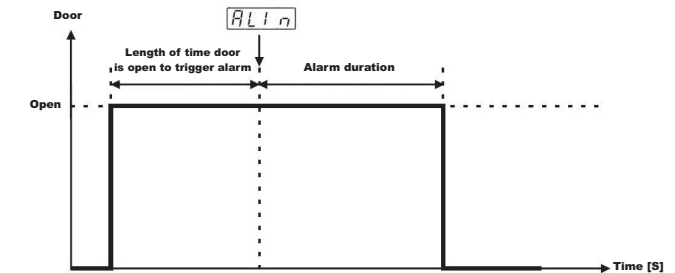

Power failure alarm **[ALno]**

When there is a power failure and the controller is off for a period longer than 1 minute, when the power returns and the controller has a temperature higher than the value set in **[F127]** (HACCP - High temperature alarm), a record will be created immediately - **[ALno]**. In this case, the information stored is: date and time of energy return and temperature value measured at the moment the controller was turned back on.

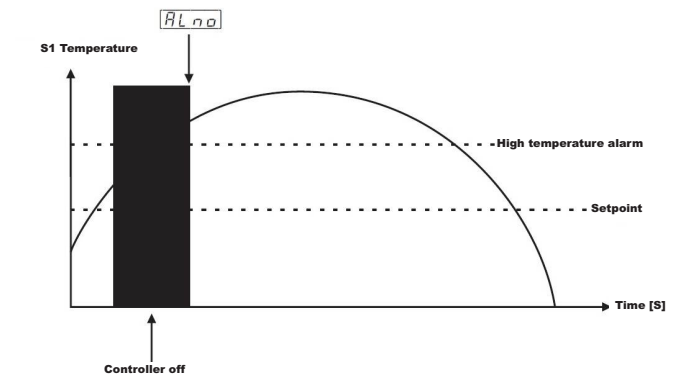

Up to 6 records of each alarm type are stored. If the number of stored records exceeds this amount, with each new alarm, the least recent record is replaced.

The visualization of the HACCP alarms must be done in the option **[HAcc]** in the main menu or in the easy menu (**▲**). The **[HAcc]** menu is subdivided according to the alarm type:

[ALH] : where are the high temperature records;

[ALL0] : low temperature records;

[ALIn] : digital input records;

[ALno] : power outage records.

To view records, follow the steps below:

- a) Select the **[HAcc]** option from the main menu and press **↵**;
- b) Choose the type of alarm to be displayed **[ALH]**, **[ALL0]**, **[ALIn]** or **[ALno]** using the **▲** or **▼** buttons and press **↵**;
- c) The controller stores up to 6 records of each type of alarm, use the **▲** or **▼** buttons to select the record number you wish to view and press **↵**;
- d) In alarms **[ALH]**, **[ALL0]** and **[ALIn]** the data will be displayed in sequence: date and time of the start of the alarm (**---d** **---m** **---y** **00:00**), alarm duration (**5649** **00:00**) and maximum / minimum temperature measured during the alarm;
- e) In **[ALno]** type alarms, the data will be displayed in sequence: date and time of the start of the alarm (**---d** **---m** **---y** **00:00**) and temperature measured at the time of power return;
- f) If there is no record stored in the chosen option, the message **[noP]** will be displayed;
- g) After displaying the alarm data, the controller returns to the HACCP alarms display menu.

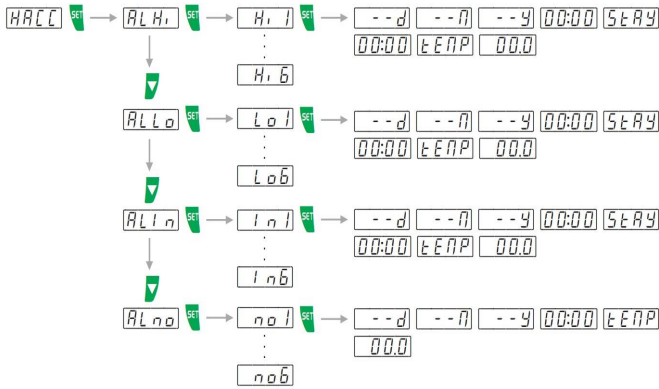

Note 1: To return to a previous menu level, keep the **SET** pressed.

Note 2: The alarm duration time and the maximum measured temperature can be updated while the alarm is occurring.

To delete all HACCP alarm records follow the steps below:

- Enter the main function menu by simultaneously pressing **DEL** and **SET** (short press) during temperature display;
- Select **[CODE]** option in the menu and press **SET**;
- Using the **DEL** or **SET** keys enter the access code 123 (one hundred and twenty three) and confirm with **SET**;
- Using the **DEL** or **SET** keys again, enter the **HACCP** menu and select the **[HSE]** option and press **SET**;
- If you are sure you want to permanently delete the HACCP alarm logs and if the access code has been entered correctly, use the **DEL** or **SET** keys select the **[YES]** option and press **SET**;
- The message **[F5E]** will be displayed and all HACCP records have been cleared. From this moment on, any new generated HACCP alarm will be stored in position 1 of the alarm category to which it belongs.

HACCP signaling

When a new HACCP alarm occurs, the indication (ccc) on the display will be lit. The indication will only be cleared after this alarm is displayed in the **HACCP** menu.

To facilitate viewing of new HACCP alarms, the dot in the lower right corner of the alarm type will be lit, indicating which alarms have not yet been viewed, as shown in the figure below.

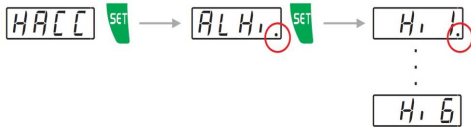

9.4.7 Scheduled Defrosting

You can configure the defrosting schedule to be equally distributed across the day by programming the number of defrost cycles per day. To do this, you need to set the start of the defrosting as part of a defrosting schedule, setting **[F19]** to 5, and configuring functions **[F28]** to **[F37]** to determine the number of defrost cycles per day and their preferred times. With this, the defrost schedule makes it possible to create a program from Monday to Friday, another program for Saturday and another for Sunday. E.g. if the program for Monday to Friday consists of a preferred time of 1 pm (and the number of defrosting cycles is 4, with an interval of 6 hours), the defrost schedule will be operate at 1:00 am, at 1:00 pm and 7:00 pm on each day.

MONDAY TO FRIDAY

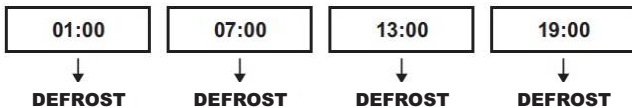

9.5 Parameters Table

MODE	Fun	Description	CELSIUS (°C)				FAHRENHEIT (°F)			
			Min	Max	Unit	Standard	Min	Max	Unit	Standard
	[CODE]	Access code: 123 (one hundred and twenty three)	0	999	-	0	0	999	-	0
	[F00]	Controller operating mode	0	2	-	0	0	2	-	0
COOLING / HEATING	[F01]	Setpoint temperature	[F03]	[F04]	°C	-9,0	[F03]	[F04]	°F	15,8
	[F02]	Desired temperature (economic setpoint)	[F03]	[F04]	°C	-4,0	[F03]	[F04]	°F	24,8
	[F03]	Minimum desired temperature (setpoint) allowed to the user	-50,0	[F04]	°C	-50,0	-58,0	[F04]	°F	-58,0
	[F04]	Maximum desired temperature (setpoint) allowed to the user	[F03]	105,0	°C	105,0	[F03]	221,0	°F	221,0
	[F05]	Operating setpoint control differential (cooling)	0,1	20,0	°C	3,0	0,1	36,0	°F	5,4
	[F06]	Economic setpoint control differential (cooling)	0,1	20,0	°C	3,0	0,1	36,0	°F	5,4
	[F07]	Operating setpoint control differential (heating)	0,1	20,0	°C	3,0	0,1	36,0	°F	5,4
	[F08]	Economic setpoint control differential (heating)	0,1	20,0	°C	3,0	0,1	36,0	°F	5,4
	[F09]	Time for economic mode to begin (Monday to Friday)	00:00	24:00(Off)	hh:mm	24:00(Off)	00:00	24:00(Off)	hh:mm	24:00(Off)
	[F10]	Time for economic mode to begin (Saturday)	00:00	24:00(Off)	hh:mm	24:00(Off)	00:00	24:00(Off)	hh:mm	24:00(Off)
	[F11]	Time for economic mode to begin (Sunday)	00:00	24:00(Off)	hh:mm	24:00(Off)	00:00	24:00(Off)	hh:mm	24:00(Off)
	[F12]	Temperature difference (S3-S1) below which the economic setpoint is activated	0,1	20,0	°C	2,0	0,1	36,0	°F	3,6
	[F13]	Temperature difference (S3-S1) above which the normal setpoint is activated	0,1	20,0	°C	5,0	0,1	36,0	°F	9,0
	[F14]	Maximum temperature in economic mode	0(Off)	999	minutes	120	0(Off)	999	minutes	120
	[F15]	Fast Freezing temperature limit	[F03]	[F04]	°C	-11,0	[F03]	[F04]	°F	12,2
	[F16]	Maximum fast freezing time	0(Off)	999	minutes	300	0(Off)	999	minutes	300
	[F17]	Delay time when powering up the controller	0(Off)	999	minutes	0(Off)	0(Off)	999	minutes	0(Off)

9.4.8 Variable compressor control

The control settings of the variable compressor differ depending on the brand and model of the variable compressor used. Consult the compressor's technical manual.

In traditional cooling applications, the demand for using the compressor at full load is rare and restricted to a few days a year. The control of the operating frequency of a variable capacity compressor adapts its use to the real demand. This way, the compressor runs at a low speed most of the time, minimizing energy consumption.

The operating frequency is proportional to the cooling capacity defined in parameters **[F74]** and **[F75]**. The parameter **[F76]** defines the maximum operating frequency of the compressor and is used in situations where it is needed to quickly lower the temperature of the controlled environment.

It is possible to keep the compressor operating continuously, keeping the temperature of the controlled environment stable and reducing the number of compressor starts, thereby resulting in energy savings. To use this characteristic, parameter **[F82]** - Variable compressor time on after reaching the setpoint must be programmed.

9.4.9 Control PID

The PID controller is made up of a combination of three control actions: Proportional action (P), Integral action (I) and Derivative action (D). Each action receives a weighting (adjustable via parameters) which represents a gain or adjustment time. This enables the PID to perform better when controlling the process. Any control action is limited by the quality and capacity of the existing actuators in the process.

P - Proportional gain (Pg) - The use of proportional action in a control system enables the difference (error) between the desired output (reference, setpoint) and the current value of the process, to be reduced. The proportional gain speeds up process's response, however, the increased gains can result in control oscillating.

I - Integral time (It) - The integral action has an energy storage function, which allows it to remove the error between the reference and the output. It accumulates the error at a "It" rate and attempts to reduce it to zero. Low It values can cause the control to oscillate, however, long It times tend to slow down the process. Integral action must not be used on its own.

D - Derivative time (Dt) - The use of derivative action enables the process's response time to be increased and reduces oscillation, as it tries to anticipate the process's behavior. Low values of Dt act in a way to reduce the oscillatory anticipating the behavior of the process, however, high Dt values will make the control very reactive, causing instability. Integral action must not be used on its own.

SUMMARY TABLE - GENERAL GUIDANCE*			
PID PARAMETER	OVERSHOOT (peak, sobressinal)	STABILIZATION TIME (delay in stabilizing the controller)	ERROR (the difference between the setpoint and the sensor)
Increase KP**	Increase	Little Effect	Reduce
Reduce Ti	Increase	Increase	Null error
Increase Td	Reduce	Reduce	No effect

Obs.: Change the parameters individually, check the response and then modify another parameter. Proceed with caution, to monitor the behavior of the process, analyze and modify the control parameters*. This guide is widely applied in the technical literature on PID controllers, however processes with latency in their response may differ from the indication in the table. The technician responsible for the process must correct small deviations manually. ** In specific applications, the behavior can be reversed to that indicated.

	Fun	Description	CELSIUS (°C)				FAHRENHEIT (°F)			
			Min	Max	Unit	Standard	Min	Max	Unit	Standard
DEFROST	[F 18]	Defrost type	0	2	-	0	0	2	-	0
	[F 19]	Condition for starting defrosting	0(Off)	5	-	1	0(Off)	5	-	1
	[F 20]	Interval between defrosts (cooling) if [F 19] = 1 or maximum time without defrosts (cool.) if [F 19] = 2, 3 or 4	1	9999	minutes	720	1	9999	minutes	720
	[F 21]	Interval between defrosts (heating) if [F 19] = 1 or maximum time without defrosts (heat.) if [F 19] = 2, 3 or 4	1	9999	minutes	720	1	9999	minutes	720
	[F 22]	Additional time at the end of the first refrigeration cycle	0(Off)	999	minutes	0(Off)	0(Off)	999	minutes	0(Off)
	[F 23]	Evaporator temperature (S2/S3 sensor) to start defrost if [F 19] = 2 or 4	-50,0	105,0	°C	-20,0	-58,0	221,0	°F	-4,0
	[F 24]	Temperature difference for defrost start (S1-S2) if [F 19] = 3 or 4	-50,0	105,0	°C	15,0	-58,0	221,0	°F	59,0
	[F 25]	Low temperature confirmation time (sensor S2/S3) to start pre-defrost if [F 19] = 2, 3 or 4	0(Off)	999	minutes	10	0(Off)	999	minutes	10
	[F 26]	Defrost when the controller is powered on	0(Off)	1(On)	-	1(On)	0(Off)	1(On)	-	1(On)
	[F 27]	Smooth Defrost if [F 18] = 0	10	100(Off)	%	100(Off)	10	100(Off)	%	100(Off)
	[F 28]	Number of defrosting per day (Monday to Friday) if [F 19] = 5	1	12	-	4	1	12	-	4
	[F 29]	Time to start defrost (Monday) if [F 19] = 5	00:00	24:00(Off)	hh:mm	06:00	00:00	24:00(Off)	hh:mm	06:00
	[F 30]	Time to start defrost (Tuesday) if [F 19] = 5	00:00	24:00(Off)	hh:mm	06:00	00:00	24:00(Off)	hh:mm	06:00
	[F 31]	Time to start defrost (Wednesday) if [F 19] = 5	00:00	24:00(Off)	hh:mm	06:00	00:00	24:00(Off)	hh:mm	06:00
	[F 32]	Time to start defrost (Thursday) if [F 19] = 5	00:00	24:00(Off)	hh:mm	06:00	00:00	24:00(Off)	hh:mm	06:00
	[F 33]	Time to start defrost (Friday) if [F 19] = 5	00:00	24:00(Off)	hh:mm	06:00	00:00	24:00(Off)	hh:mm	06:00
	[F 34]	Number of defrosts per day (Saturday) if [F 19] = 5	1	12	-	4	1	12	-	4
	[F 35]	Time to start Defrost (Saturday) if [F 19] = 5	00:00	24:00(Off)	hh:mm	06:00	00:00	24:00(Off)	hh:mm	06:00
	[F 36]	Number of defrosts per day (Sunday) if [F 19] = 5	1	12	-	4	1	12	-	4
	[F 37]	Time to start defrost (Sunday) if [F 19] = 5	00:00	24:00(Off)	hh:mm	06:00	00:00	24:00(Off)	hh:mm	06:00
[F 38]	Length of pre-defrost (collecting in gas)	0(Off)	999	minutes	0(Off)	0(Off)	999	minutes	0(Off)	
[F 39]	Evaporator temperature (S2/S3 sensor) to end defrost	-50,0	105,0	°C	40,0	-58,0	221,0	°F	104,0	
[F 40]	Ambient temperature (S1 sensor) required to end the defrost	-50,0	105,0	°C	20,0	-58,0	221,0	°F	68,0	
[F 41]	Maximum time on defrost (for safety)	1	999	minutes	30	1	999	minutes	30	
[F 42]	Draining time (from water collected from defrosting)	0(Off)	999	minutes	1	0(Off)	999	minutes	1	
[F 43]	Enable tray defrost	0(Off)	2	-	0(Off)	0(Off)	2	-	0(Off)	
FAN	[F 44]	Fan type	0	2	-	0	0	2	-	0
	[F 45]	Fan operation mode	0	4	-	4	0	4	-	4
	[F 46]	Time fan is on if [F 45] = 0 or 4	1	999	minutes	2	1	999	minutes	2
	[F 47]	Time fan is turned off if [F 45] = 0 (automatic timed mode)	1	999	minutes	8	1	999	minutes	8
	[F 48]	Temperature in the evaporator to switch the fan back on after draining	-50,0	105,0	°C	2,0	-58,0	221,0	°F	35,6
	[F 49]	Maximum length of time until the fan is switched back on after drainage (fan-delay)	0(Off)	999	minutes	1	0(Off)	999	minutes	1
	[F 50]	Fan cut off due to high temperature in the evaporator (S2 sensor)	-50,0	105,0	°C	50,0	-58,0	221,0	°F	122,0
[F 51]	Open door time to turn off fan	-1(Off)	9999	seconds	-1(Off)	-1(Off)	9999	seconds	-1(Off)	
VARIABLE FAN	[F 52]	Variable fan control temperature	-50,0	105,0	°C	-12,0	-58	221,0	°F	10,4
	[F 53]	Variable fan control differential (hysteresis)	1,0	99,0	°C	20,0	1,8	178,2	°F	36,0
	[F 54]	Minimum variable fan speed	0	[F 55]	%	30	0	[F 55]	%	30
	[F 55]	Maximum variable fan speed	[F 54]	100	%	100	[F 54]	100	%	100
	[F 56]	Variable fan speed with compressor off	0(Off)	[F 54]	%	0(Off)	0(Off)	[F 54]	%	0(Off)
	[F 57]	Max speed start time	0(Off)	999	seconds	30	0(Off)	999	seconds	30
	[F 58]	Variable fan time on at minimum speed to activate anti-freeze protection	0(Off)	999	minutes	0(Off)	0(Off)	999	minutes	0(Off)
[F 59]	Variable fan time on at maximum speed during anti-freeze protection	10	999	seconds	10	10	999	seconds	10	
DIGITAL INPUTS/ AUXILIARY SENSOR	[F 60]	Operating mode of digital input 1 / sensor S3	0(Off)	24	-	2	0(Off)	24	-	2
	[F 61]	Operating mode of digital input 2 / sensor S4	0(Off)	21	-	0(Off)	0(Off)	21	-	0(Off)
	[F 62]	Door open time for instant defrost	0(Off)	999	minutes	30	0(Off)	999	minutes	30
	[F 63]	Open door time to shut down compressor and fan	0(Off)	999	minutes	5	0(Off)	999	minutes	5
	[F 64]	Door closed time to turn off the lamp	0(Off)	999	minutes	120	0(Off)	999	minutes	120
[F 65]	Closed door time to activate economy mode	0(Off)	999	minutes	180	0(Off)	999	minutes	180	
COMPRESSOR	[F 66]	Compressor type	0	2	-	0	0	2	-	0
	[F 67]	Minimum time for the compressor to be on	0(Off)	9999	seconds	0(Off)	0(Off)	9999	seconds	0(Off)
	[F 68]	Minimum time for the compressor to be off	0(Off)	9999	seconds	0(Off)	0(Off)	9999	seconds	0(Off)
	[F 69]	Compressor on time in case of error on sensor S1 (room temperature)	0(Off)	999	minutes	20	0(Off)	999	minutes	20
[F 70]	Compressor off time in case of error in sensor S1 (room temperature)	0(Off)	999	minutes	10	0(Off)	999	minutes	10	
VARIABLE COMPRESSOR	[F 71]	Proportional gain (P)	1,0	100,0	-	2,0	1,0	100,0	-	2,0
	[F 72]	Integral time (I)	1	500	seconds	50	1	500	seconds	50
	[F 73]	Derivative time (D)	0(Off)	500	seconds	0(Off)	0(Off)	500	seconds	0(Off)
	[F 74]	Minimum frequency for variable compressor PID control	30	[F 75]	Hz	60	30	[F 75]	Hz	60
	[F 75]	Maximum frequency for variable compressor PID control	[F 74]	[F 76]	Hz / %	120	[F 74]	[F 76]	Hz / %	120
	[F 76]	Maximum frequency for variable compressor operation	30	300	Hz / %	150	30	300	Hz / %	150
	[F 77]	Variable compressor stop frequency (switch-off)	0	50	Hz	30	0	50	Hz	30
	[F 78]	Variable compressor frequency during a hot gas defrost	[F 74]	[F 76]	Hz / %	120	[F 74]	[F 76]	Hz / %	120
	[F 79]	Variable compressor frequency in the event of an error in sensor S1 (room sensor)	[F 74]	[F 75]	Hz / %	100	[F 74]	[F 75]	Hz / %	100
	[F 80]	Variable compressor smooth start frequency	[F 74]	[F 75]	Hz / %	60	[F 74]	[F 75]	Hz / %	60
	[F 81]	Variable compressor smooth start time	1	999	seconds	30	1	999	seconds	30
	[F 82]	Variable compressor time on after reaching the setpoint	0(Off)	999(On)	minutes	120	0(Off)	999(On)	minutes	120
	[F 83]	Variable compressor time below threshold frequency [F 85] for lubrication	10(Off)	1440	minutes	10(Off)	10(Off)	1440	minutes	10(Off)
	[F 84]	Variable compressor time on frequency [F 76] for compressor lubrication	10	999	seconds	30	10	999	seconds	30
	[F 85]	Minimum frequency for variable compressor lubrication control	[F 74]	[F 75]	Hz / %	80	[F 74]	[F 75]	Hz / %	80
[F 86]	Maximum time for the variable compressor turned on to maximum frequency	0(Off)	9999	minutes	600	0(Off)	9999	minutes	600	
[F 87]	Low temperature limit (differential for the temperature setpoint)	1,0(Off)	99,9	°C	3,0	1,8(Off)	179,8	°F	5,4	
[F 88]	High temperature limit (differential for the temperature setpoint)	1,0(Off)	99,9	°C	11,0	1,8(Off)	179,8	°F	19,8	
AUXILIARY OUTPUT/ALARMS	[F 89]	AUX output mode	0(Off)	7	-	1	0	7	-	1
	[F 90]	Time to turn on the AUX output if [F 89] = 5 (Monday to Friday)	00:00	23:59	hh:mm	00:00	00:00	23:59	hh:mm	00:00
	[F 91]	Time to turn off the AUX output if [F 89] = 5 (Monday to Friday)	00:00	24:00(Off)	hh:mm	24:00(Off)	00:00	24:00(Off)	hh:mm	24:00(Off)
	[F 92]	Time to turn on the AUX output if [F 89] = 5 (Saturday)	00:00	23:59	hh:mm	00:00	00:00	23:59	hh:mm	00:00
	[F 93]	Time to turn off AUX output if [F 89] = 5 (Saturday)	00:00	24:00(Off)	hh:mm	24:00(Off)	00:00	24:00(Off)	hh:mm	24:00(Off)
	[F 94]	Time to turn on the AUX output if [F 89] = 5 (Sunday)	00:00	23:59	hh:mm	00:00	00:00	23:59	hh:mm	00:00
	[F 95]	Time to turn off the AUX output if [F 89] = 5 (Sunday)	00:00	24:00(Off)	hh:mm	24:00(Off)	00:00	24:00(Off)	hh:mm	24:00(Off)
	[F 96]	Operating mode for ambient temperature alarms (S1) (0-relative/1-absolute)	0	1	-	0	0	1	-	0
	[F 97]	Low ambient temperature alarm (S1)	-50,0	105,0	°C	-50,0	-58,0	221,0	°F	-58,0
[F 98]	High ambient temperature alarm (S1)	-50,0	105,0	°C	105,0	-58,0	221,0	°F	221,0	

	Fun	Description	CELSIUS (°C)				FAHRENHEIT (°F)			
			Min	Max	Unit	Standard	Min	Max	Unit	Standard
AUXILIARY OUTPUT/ALARMS	[F 99]	Length of time door is open to trigger alarm	0 (Off)	999	minutes	5	0 (Off)	999	minutes	5
	[F 100]	Alarm validation time by temperature	0 (Off)	999	minutes	0 (Off)	0 (Off)	999	minutes	0 (Off)
	[F 101]	Alarm inhibit time on power-up	0 (Off)	999	minutes	0 (Off)	0 (Off)	999	minutes	0 (Off)
	[F 102]	Maximum compressor on time without reaching the desired temperature (setpoint)	0 (Off)	999	hours	0 (Off)	0 (Off)	999	hours	0 (Off)
	[F 103]	Maximum compressor operating time for maintenance alarm (hour meter)	0 (Off)	9999	hours	0 (Off)	0 (Off)	9999	hours	0 (Off)
	[F 104]	Trigger for alarm when defrosting is over based on time	0 (Off)	1 (On)	-	0 (Off)	0 (Off)	1 (On)	-	0 (Off)
	[F 105]	Desired temperature for anti-condensation (sensor 3 heating setpoint)	-50,0	105,0	°C	30,0	-58,0	221,0	°F	86,0
	[F 106]	Control differential for anti-condensation (S3)	0,1	20,0	°C	3,0	0,1	36,0	°F	5,4
GASKET HEATING	[F 107]	Enables audible alarm (buzzer)	0 (Off)	1 (On)	-	1 (On)	0 (Off)	1 (On)	-	1 (On)
	[F 108]	Enables gasket heating control	0(Off)	2	-	0(Off)	0(Off)	2	-	0(Off)
	[F 109]	Temperature limit for gasket heating control activation	1,0	50,0	°C	1,0	33,8	122,0	°F	33,8
	[F 110]	Desired temperature differential for gasket heating control	0,1	20,0	°C	2,0	0,1	36,0	°F	3,0
	[F 111]	Output on time for gasket heating control	1	9999	minutes	7	1	9999	minutes	7
CONDENSER	[F 112]	Output off time for gasket heating control	0	9999	minutes	3	0(Off)	9999	minutes	3
	[F 113]	High condenser temperature alarm (S3) (visual and audible only)	0(Off)	105,0	°C	105,0	32,0 (Off)	221,0	°F	221,0
PRESSURE GAUGE	[F 114]	Maximum condenser temperature (S3) to turn off control outputs	0 (Off)	105,0	°C	105,0	32,0 (Off)	221,0	°F	221,0
	[F 115]	Control differential for maximum condenser temperature (hysteresis)	0,1	20,0	°C	3,0	0,1	36,0	°F	5,4
	[F 116]	Time to confirm High pressure alarm	0	60	seconds	5	0	60	seconds	5
VOLTAGE MONITOR	[F 117]	Time to confirm Low pressure alarm	0	180	seconds	20	0	180	seconds	20
	[F 118]	Time to start delay to monitor low pressure alarm	30	600	seconds	60	30	600	seconds	60
	[F 119]	Delay time after high pressure alarm to resume temperature control	1	10	minutes	3	1	10	minutes	3
	[F 120]	Delay time after low pressure alarm to resume temperature control	1	10	minutes	3	1	10	minutes	3
HACCP	[F 121]	Minimum supply voltage	10	40	Vdc	10	10	40	Vdc	10
	[F 122]	Maximum supply voltage	10	40	Vdc	40	10	40	Vdc	40
	[F 123]	Voltage indication offset	-10,0	10,0	Vdc	0,0	-10,0	10,0	Vdc	0,0
	[F 124]	Voltage validation offset	1	30	seconds	5	1	30	seconds	5
DATALOGGER	[F 125]	Enable logging of HACCP alarms	0 (Off)	1 (On)	-	0 (Off)	0 (Off)	1 (On)	-	0 (Off)
	[F 126]	HACCP - Low room temperature alarm	-50,0	[F 127]	°C	-50,0	-58,0	[F 127]	°F	-58,0
	[F 127]	HACCP - High room temperature alarm	[F 128]	105,0	°C	105,0	[F 128]	221,0	°F	221,0
	[F 128]	HACCP - Alarm inhibit time	0 (Off)	999	minutes	0 (Off)	0 (Off)	999	minutes	0 (Off)
SENSORS	[F 129]	Datalogger operation mode	0 (Off)	2	-	2	0 (Off)	2	-	2
	[F 130]	Sampling period (time between memory records)	10	999	seconds	30	10	999	seconds	30
	[F 131]	Minimal change in room temperature to force write data to memory	0 (Off)	10,0	°C	0 (Off)	0 (Off)	18,0	°F	0 (Off)
	[F 132]	Variation of digital input or outputs to force writing of data	0 (Off)	1 (On)	-	0 (Off)	0 (Off)	1 (On)	-	0 (Off)
FUNCTIONS	[F 133]	Overwrite old records when memory is full?	0 (Off)	1 (On)	-	1 (On)	0 (Off)	1 (On)	-	1 (On)
	[F 134]	Digital filter actuation mode	0	1	-	0	0	1	-	0
	[F 135]	Intensity of the digital filter on the room temperature sensor (S1 sensor) (Rising)	0 (Off)	20	seconds	0 (Off)	0 (Off)	20	seconds	0 (Off)
	[F 136]	Intensity of the digital filter on the room temperature sensor (S1 sensor) (Descending)	0 (Off)	20	seconds	0 (Off)	0 (Off)	20	seconds	0 (Off)
	[F 137]	Displacement of the values from the room sensor (S1 sensor)	-20,1 (Off)	20,0	°C	0,0	-36,0	36,1 (Off)	°F	0,0
	[F 138]	Displacement of the values from the evaporator sensor (S2 sensor)	-20,0	20,0	°C	0,0	-36,0	36,0	°F	0,0
FUNCTIONS	[F 139]	Auxiliary sensor indication offset (S3 sensor)	-20,0	20,0	°C	0,0	-36,0	36,0	°F	0,0
	[F 140]	Auxiliary sensor indication offset (S4 sensor)	-20,0	20,0	°C	0,0	-36,0	36,0	°F	0,0
	[F 141]	Preferred indication on the display	1	5	-	1	1	5	-	1
	[F 142]	Ambient temperature (S1 sensor) value locked in during defrosting	0	2	-	1	0	2	-	1
	[F 143]	Maximum length of time that the temperature is locked during defrosting	0 (Off)	999	minutes	15	0 (Off)	999	minutes	15
	[F 144]	Function lock mode	0	2	-	0	0	2	-	0
	[F 145]	Function lock period	15	60	seconds	15	15	60	seconds	15
[F 146]	Turn off control functions	0 (Off)	2	-	0 (Off)	0 (Off)	2	-	0 (Off)	
[F 147]	Address of the instrument on the RS-485 network	1	247	-	1	1	247	-	1	

[F 00] - Controller operating mode:

[0] – Refrigeration / Cooling

The compressor turns off when the temperature of sensor S1 (room temperature) is less than or equal to the Setpoint and restarts when the temperature of sensor S1 is equal to the (Setpoint + Differential of control in refrigeration).

[1] – Heating

The compressor turns off when the temperature of sensor S1 (room temperature) is greater than or equal to the Setpoint and restarts when the temperature of sensor S1 is equal to the (Setpoint - Heating control differential).

[2] – Automatic

In this operating mode, the AUX output is configured for cycle reversing valve and it is not possible to change its value.

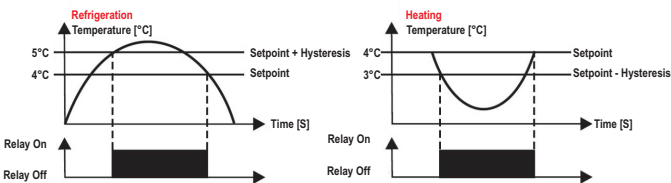

If cooling is active (AUX relay off)

The compressor turns off when the temperature of sensor S1 (room temperature) is less than or equal to the Setpoint and restarts when the temperature of sensor S1 is equal to the (Setpoint + Differential of control in refrigeration).

If the temperature drops to (Setpoint - Heating control differential), the cycle is reversed and the controller starts to control the temperature by heating the room. At this time the AUX relay is turned on.

If heating is active (AUX relay on)

The compressor turns off when the temperature of sensor S1 (room temperature) is greater than or equal to the Setpoint and restarts when the temperature of sensor S1 is equal to the (Setpoint - Heating control differential).

If the temperature increases to (Setpoint + Control differential in cooling), the cycle is inverted and the controller starts to control the temperature, cooling the environment. At this time the AUX relay is turned off.

[F 01] - Desired temperature (setpoint):

It is the control temperature of the normal operating mode, that is, it is the temperature that you want to maintain in the controlled environment.

[F 02] - Desired temperature (economic setpoint):

It is the control temperature when the economy operating mode is on.

[F 03] - Minimum desired temperature (setpoint) allowed to the user:

[F 04] - Maximum desired temperature (setpoint) allowed to the user:

Limits set in order to avoid excessively high or low temperatures being accidentally set for the temperature setpoint, which could lead to high energy consumption by keeping the system on continuously.

[F 05] - Operating setpoint control differential (cooling):

[F 06] - Economic setpoint control differential (cooling):

It is the temperature difference between turning the cooling off and on again.

[F 07] - Operating setpoint control differential (heating):

[F 08] - Economic setpoint control differential (heating):

It is the temperature difference between turning the heating OFF and ON.

[F 09] - Time for Economic Mode to begin (Monday to Friday):

Time when the economic setpoint [SP-E] will be activated on working days.

This function can be turned off by setting it to the maximum value [FFF].

[F 10] - Time for Economic Mode to begin (Saturday):

Time when the economic setpoint [SP-E] will be activated on Saturdays.

This function can be turned off by setting it to the maximum value [FFF].

[F 11] - Time for Economic Mode to begin (Sunday):

Time when the economic setpoint [SP-E] will be activated on Sundays.

This function can be turned off by setting it to the maximum value [FFF].

[F 12] - Temperature difference (S3-S1) below which the economic setpoint is activated:

When the temperature difference between sensor 3 and sensor 1 is less than the value set in this

parameter, the controller starts to operate in economy mode.

[F 13] - Temperature difference (S3-S1) above which the normal setpoint is activated:

When the temperature difference between sensor 3 and sensor 1 is greater than the value set in this parameter, the controller starts to operate with normal setpoint.

[F 14] - Maximum temperature in economic mode:

Allows you to set the maximum length of time economy mode will operate for. After this time, the setpoint returns to economy mode in normal operation. If this is set to [0FF] this time will be ignored.

[F 15] - Fast Freezing temperature limit:

This is the minimum temperature that the instrument can reach during the Fast Freezing process.

[F 16] - Maximum Fast Freezing time:

This the duration of the Fast Freezing process.

[F 17] - Delay time when powering up the controller:

When the instrument is turned on, it can remain disabled for a while, delaying the start of the process. During this time it only works as a temperature gauge. Helps to avoid high demands for power, when power returns after a power cut, where several pieces of equipment are all on the same connection. Therefore, you can set different times for each device. This delay can relate to the compressor or defrosting (where defrosting is part of the sequence).

[F 18] - Defrost type:

- 0 - Electrical Defrosting (using coils), which only applies to the defrost outlet;
- 1 - Hot gas Defrosting, which only applies to the compressor and defrosting outlets;
- 2 - Natural defrosting, which only applies to the fan outlet.

[F 19] - Condition for starting defrosting:

- 0FF - No automatic defrosting, only manual defrosting;
- 1 - Defrost initiated by time;
- 2 - Defrost initiated by temperature;
- 3 - Set temperature difference (S1-S2) to start defrosting;
- 4 - Set temperature and temperature difference (S1-S2) to start defrosting;
- 5 - Defrost schedule.

[F 20] - Interval between defrosts (cooling) if [F 19] = 1 or Maximum time without defrosts (cooling) if [F 19] = 2, 3 or 4:

[F 21] - Interval between defrosts (heating) if [F 19] = 1 or Maximum time without defrosts (heating) if [F 19] = 2, 3 or 4:

It determines how often and after how long defrosting. If the controller is configured to perform defrost by temperature ([F 19] = 2, 3 or 4), this time acts as a safety measure in situations where the evaporator temperature (sensor S2) does not reach the values programmed in [F 23] or [F 24]. This function determines the maximum time that the controller will wait before carrying out defrosting.

[F 22] - Additional time at the end of the first refrigeration cycle:

This is to set a longer period of time for the first refrigeration cycle. Where there are setups with several pieces of equipment, you can avoid high demand peaks by ensuring that defrosting takes place at different times by assigning different values to this function.

[F 23] - Temperature of the evaporator (S2 sensor) in order to begin defrosting if [F 19]=2 or 4:

When the temperature of the evaporator (S2 sensor) reaches a value using this function, the controller will wait for the length of time before beginning defrosting.

[F 24] - Temperature Difference in order to start defrosting (S1 - S2) if [F 19] = 3 or 4:

When the difference between the temperature of the room sensor (S1 sensor) and the temperature of the evaporator (S2 sensor) reaches a value using this function, the controller will wait for the length of time before beginning defrosting.

[F 25] - Time to confirm the lower temperature (sensor S2/ S3) to start the pre-defrost [F 19] = 2, 3 or 4:

If the controller is configured to perform defrosting by temperature or temperature difference, at the moment the temperature of sensor S2 ([F 19] = 2 or 4) or the difference (S1 - S2) ([F 19] = 3) reaches the configured value, the confirmation time starts counting to start pre-defrosting. During this step, if the temperature of sensor S2 remains low or the difference (S1 - S2) remains high, pre-defrosting starts. Otherwise, the system continues in the cooling stage.

[F 26] - Defrost when the controller is powered on:

This enables a defrosting to be conducted when the controller is powered on. For example, when the electricity returns after a power cut.

[F 27] - Smooth Defrost if F18=0:

Smooth Defrost mode provides a smoother defrosting, saving energy and preventing the room temperature from rising as much as in a standard defrost. In this mode, the defrost output remains on as long as the evaporator temperature (S2 sensor) is less than 2°C (35.6°F) and, after passing that temperature, the output remains on for the percentage of time configured in this function, within a 2 minute period.

[F 28] - Number of defrosts per day (Monday to Friday) if [F 19] = 5:

The defrosts are distributed at equal intervals according to the programming of the number of defrosts per day, always considering the preferred time, being able to adjust the values in 1, 2, 3, 4, 6, 8 or 12. Monday to Friday.

[F 29] - Time to start defrost (Monday) if [F 19] = 5:

[F 30] - Time to start defrost (Tuesday) if [F 19] = 5:

[F 31] - Time to start defrost (Wednesday) if [F 19] = 5:

[F 32] - Time to start defrost (Thursday) if [F 19] = 5:

[F 33] - Time to start defrost (Friday) if [F 19] = 5

Enables the preferred start time of one of the daily defrost cycles to be adjusted.

This function is to program this for Monday to Friday.

[F 34] - Number of Defrostings per day (Saturday) if [F 19] = 5:

Defrosting is set to take place at equal intervals according to the number programmed per day, always taking preferred times into account. It can be adjusted using values of 1, 2, 3, 4, 6, 8 or 12. This function is to program this for Saturday.

[F 35] - Time to start defrost (Saturday) if [F 19] = 5:

Enables the preferred start time of one of the daily defrost cycles to be adjusted.

This function is to program this for Saturday.

[F 36] - Number of Defrostings per day (Sunday) if [F 19] = 5:

Defrosting is set to take place at equal intervals according to the number programmed per day, always taking preferred times into account. It can be adjusted using values of 1, 2, 3, 4, 6, 8 or 12. This function is to program this for Sunday.

[F 37] - Time to start Defrost (Sunday) if [F 19] = 5:

Enables the preferred start time of one of the daily defrost cycles to be adjusted.

This function is to program this for Sunday.

[F 38] - Length of pre-defrost (collecting in gas):

When the defrost starts, the controller will only use the fan during this time, in order to take advantage of the residual energy of the gas.

[F 39] - Evaporator temperature (sensor S2/ S3) to end defrost:

If the temperature in the evaporator reaches the set value, the end of defrost will take place as desired, that is, by temperature. This way it improves the defrosting process. If sensor S3 is configured as the second evaporator sensor, the controller will turn off the defrost outputs individually and the defrost process will be terminated when both are turned off.

[F 40] - Temperature of the Ambient Sensor (S1 sensor) to finish the defrost:

If the room temperature (sensor S1) reaches the set value, the defrost cycle will be halted due to temperature.

[F 41] - Maximum time on defrost (for safety):

This function adjusts the maximum duration of a defrost cycle. If the defrosting is not complete, during this period, according to the temperature, a dot will begin flashing in the lower right corner of the display, indicating that the time set for the defrost has ended by the required temperature has not been reached. This can happen when the temperature set is too high, the time limit is insufficient, the S2 sensor is disconnected or it isn't in contact with the evaporator.

[F 42] - Draining time (from water collected from defrosting):

Time required for removing excess water, i.e for the last drops of water to drain from the evaporator. During this period, all outputs remain switched off.

This function can be turned off by setting it to the minimum value [0FF].

[F 43] - Enable tray Defrost:

- 0FF - Deactivates tray defrosting;
- 1 - Defrosting the tray using the FAN outlet;
- 2 - Defrosting the tray using the AUX outlet;

The chosen output acts as a second defrosting output. This output is activated during the pre-defrost, defrost and drain periods. The functionality related to the control of this output (FAN or AUX) will be disregarded.

Note: Defrosting the tray using the FAN output does not prevent the use of the variable speed fan (VSF).

[F 44] - Fan type:

- 0 - On-Off type fixed speed fan (relay output);
- 1 - Variable speed fan controlled by evaporator temperature. Speed increases when evaporator temperature decreases;
- 2 - Variable speed fan controlled by room temperature. The speed increases when the ambient temperature increases.

Note: Parameters [F 45] to [F 51] adjust the **fixed speed fan operation** and parameters [F 48] to [F 59] adjust the **variable speed fan operation** (Variable Speed Fan "VSF" output from 0 to 10Vdc).

[F 45] - Fan operation mode:

- 0 - Automatic according to time: the fan will be on when the compressor is on. When the compressor is off, the fan will oscillate according to the times set in [F 46] and [F 47];
- 1 - With the compressor on, the fan is on. With the compressor off, the fan turns on when the temperature is higher than the setpoint + 60% of the hysteresis and turns off when the temperature is lower than the setpoint + 20% of the hysteresis;
- 2 - Continuous: the fan is always on;
- 3 - Dependent: the fan operates together with the compressor.
- 4 - For a period of time after the compressor is turned off: after turning off the compressor, the fan will remain on for the time set in [F 46].

Note1: Mode 1 will activate the fan only if the temperature of sensor S2 is lower than the temperature of sensor S1.

Note 2: Mode 1 will activate the fan only if the temperature of sensor S2 is lower than the configured setpoint.

[F 46] - Fan on time if [F 45] = 0 or 4:

This is how long the fan is ON for.

[F 47] - Time fan is turned off if [F 45] = 0 (automatic timed mode):

This is how long the fan is OFF for.

[F 48] - Temperature in the evaporator to switch the fan back on after draining:

After drainage is complete, it starts a fan-delay cycle. The compressor will start up immediately, because the temperature in the evaporator is high, but the fan will only start after the temperature in the evaporator falls below the set value. This function is used to remove the heat that still exists in the evaporator due to the defrost, avoiding throwing it into the environment.

[F 49] - Maximum time for fan return after draining (Fan-delay):

For safety, if the temperature in the evaporator does not reach the value set by function [F 48] or the S2 sensor is disconnected, the fan will only come on after the time set for this function has expired.

[F 50] - Fan cut off due to high temperature in the evaporator (S2 sensor):

This is intended to disconnect the evaporator fan when the room temperature is not within the design range for the refrigeration device, avoiding high temperatures and suction pressures that could damage the compressor. If the temperature in the evaporator exceeds the set value, the fan is turned off and will be restarted with a fixed hysteresis of 2°C (3.6°F). This is a useful function to use when, for example, a refrigerator is used that has been idle for days or when restocking units or counters with products.

[F 51] - Open door time to turn off fan:

This is the length of time that the fan will continue to run after the door is opened. If you set a minimum value of [0FF], the fan will not switch off if the door is opened. If you set a value of [0], the fan will switch off immediately if the door is opened.

[F52] - Variable fan control temperature:

It is the lower temperature limit, below which the fan will operate at maximum (if [F44] = 1) or minimum (if [F44] = 2) speed.

[F53] - Variable fan control differential (hysteresis):

If [F44]=1, this parameter represents the temperature range where the fan will vary the speed between high and low limits. The fan will turn off when the temperature in the evaporator (sensor S2) reaches the upper limit ([F52] + [F53]).

If [F44]=2, this parameter is used to turn off the fan when the room temperature (sensor S1) reaches the lower limit ([F52] - [F53]).

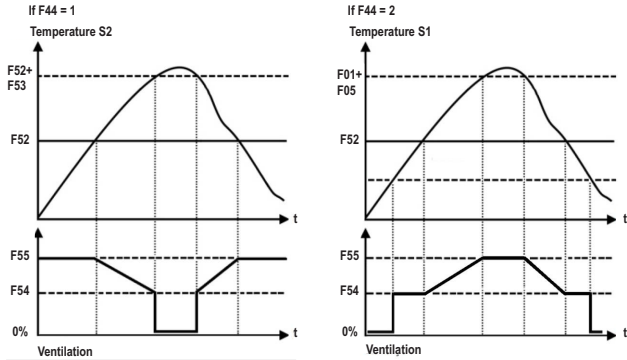

F01 = Desired temperature (setpoint)
 F02 = Desired temperature (economic setpoint)
 F05 = Operating setpoint control differential
 F06 = Economic setpoint control differential
 F52 = Fan control temperature
 F53 = Fan control differential (hysteresis)
 F54 = Minimum fan speed
 F55 = Maximum fan speed

Note: If economizer mode is activated, functions F01 and F05 will be replaced by F02 and F06, respectively.

[F54] - Minimum variable fan speed:

[F55] - Maximum variable fan speed:

Set the minimum and maximum fan speeds.

[F56] - Variable fan speed with compressor off:

Sets the variable fan speed when the compressor is off.

If the defrost is of the natural type, the fan will remain on at this speed during the pre-defrost and defrost stages.

By setting this parameter to the minimum value [FFFF], the variable fan will turn off at the same time as the compressor.

[F57] - Start time at maximum speed:

When turning on the variable fan it is kept at a high speed for a few seconds, as set in [F55]. The purpose of this feature is to apply an initial torque to make the fan motor easier to run.

[F58] - Time of variable fan on at minimum speed to activate anti-freeze protection:

Time in which the variable fan must be on with the speed configured in [F54] to operate at the maximum speed configured in [F55] for the time configured in [F59].

This process of periodically accelerating the control speed prevents ice from forming on the fan blades.

[F59] - Time of variable fan on at maximum speed during anti-freeze protection:

Maximum time of fan on at maximum speed [F55] during antifreeze protection. This parameter works together with [F58].

[F60] - Digital input 1 operating mode / sensor S3:

- [0]: Digital input disabled;
- [1]: NO Contact - Door sensor;
- [2]: NC Contact - Door sensor;
- [3]: NO Contact - External alarm (indication only);
- [4]: NC Contact - External alarm (indication only);
- [5]: NO Contact - Control shutdown;
- [6]: NC Contact - Control shutdown;
- [7]: NO button - Eco mode;
- [8]: NC button - Eco mode;
- [9]: NO pushbutton - Fast Freezing;
- [10]: NC pushbutton - Fast Freezing;
- [11]: NO pushbutton - Defrost;
- [12]: NC pushbutton - Defrost;
- [13]: NO Contact - Combined defrost;
- [14]: NC Contact - Combined defrost;
- [15]: NO Contact - Lighting;
- [16]: NC Contact - Lighting;
- [17]: NO Contact - Pressure switch status 1;
- [18]: NC Contact - Pressure switch status 1;
- [19]: NO Contact - High pressure switch;
- [20]: NC Contact - High pressure switch;
- [21]: Sensor S3 - Temperature differential for economic setpoint (S3-S1);
- [22]: Sensor S3 - Condenser temperature control;
- [23]: Sensor S3 - Second evaporator temperature control;
- [24]: Sensor S3 - Door temperature control, anti-condensation.

[F61] - Digital input 2 operating mode / sensor S4:

- [0]: Digital input disabled;
- [1]: NO Contact - Door sensor;
- [2]: NC Contact - Door sensor;
- [3]: NO Contact - External alarm (indication only);
- [4]: NC Contact - External alarm (indication only);
- [5]: NO Contact - Control shutdown;
- [6]: NC Contact - Control shutdown;
- [7]: NO button - Eco mode;
- [8]: NC button - Eco mode;
- [9]: NO pushbutton - Fast Freezing;
- [10]: NC pushbutton - Fast Freezing;
- [11]: NO pushbutton - Defrost;

- [12]: NC pushbutton - Defrost;
- [13]: NO Contact - Combined defrost;
- [14]: NC Contact - Combined defrost;
- [15]: NO Contact - Lighting;
- [16]: NC Contact - Lighting;
- [17]: NO Contact - Pressure switch status 2;
- [18]: NC Contact - Pressure switch status 2;
- [19]: NO Contact - Low pressure switch;
- [20]: NC Contact - Low pressure switch;
- [21]: Sensor S4 - Insufflation temperature (indication).

Note 1: When the digital input is configured as a pressure switch contact, it allows turning off the compressor, fan and defrost outputs, displaying the alarm associated with the source input. When the pressure switch event clears, the controller returns to the configured initial process.

Note 2: When the digital input is configured as combined defrost, defrost is started (if allowed) when the contact is closed and advances to the next step only when the contact is opened again.

Note 3: In options 5 and 6, the Sitrad supervisory system has priority over the digital input. This, if Sitrad sends a command to turn the control functions on/off, the digital input is temporarily disabled and a transition in its state will be necessary to enable it again.

[F62] - Door open time for instant defrost:

If the door is kept open for a period longer than that defined in this function, instant defrosting will take place, as long as the temperature in the evaporator (S2/S3 sensor) is less than [F39] and the room temperature (S1 sensor) is less than [F40].

[F63] - Door open time to turn off compressor and fan:

For safety, if the door open time is longer than the time configured in this function, both the compressor (COMP or COMP VCC) and the fan (FAN or FAN VSF) will be turned off.

[F64] - Door closed time to turn off the lamp:

With the door closed, this parameter defines how long it will be until the lamp is turned off. Helps save electricity.

[F65] - Door closed time to activate economy mode:

With the door closed, this parameter defines how long until economy mode is activated. The output for the lamp will be deactivated if it is turned on and the operational setpoint is switched to the economy setpoint.

[F66] - Compressor type:

- [0] - On-Off type fixed speed compressor (relay output).
- [2] - Variable Capacity Compressor - VCC with frequency output 0 to 300Hz.
- [3] - Variable Capacity Compressor - VCC with voltage output from 0 to 10Vdc.

Note1: The operation of the variable speed compressor (options 2 and 3) is conditioned only to the cooling operation mode ([F67]=0).

Note2: If [F66] = 1, parameters [F71] to [F88] are ignored and traditional control is performed via the compressor relay.

Note3: If [F66] = 3, the compressor frequency adjustment parameters are configured as a percentage (0 to 100%) that correspond directly to the 0 to 10Vdc signal applied to the COMP output VCC. Values greater than 100% will be considered as 100%.

Note4: If [F66] = 2 or 3, the relay compressor output is on while the variable compressor is on (optional use as a solenoid).

[F67] - Minimum time for compressor to be on:

This is the minimum amount of time the compressor will be on, i.e. The period of time between the last section and the next time it is stopped. This helps to avoid power surges from the electric grid.

[F68] - Minimum time for compressor to be off:

This is the minimum amount of time the compressor will be off, i.e. The period of time between the last time it stops and the next section. This helps to relieve the discharge pressure and increases the working life of the compressor.

[F69] - Compressor on time in case of error in sensor S1 (room temperature):

[F70] - Compressor off time in case of error in sensor S1 (room temperature):

If the room sensor (S1 sensor) is disconnected or goes out of the measurement range, the compressor will switch on or off according to the parameters set in these functions.

[F71] - Proportional Gain (P):

Determines the proportional increase based on the PID Control Algorithm.

[F72] - Integral Time (I):

Determines the Integral Time based on the PID Control Algorithm.

[F73] - Derivative Time (D):

Determines the derivative time of the PID Control Algorithm.

[F74] - Minimum frequency for variable compressor PID control:

Defines the minimum working frequency of the variable compressor in automatic control mode (PID algorithm).

Note: check the technical manual of the variable compressor.

Note: If [F66] = 3, the value configured in this parameter is ignored and considered as 0%.

[F75] - Maximum frequency for variable compressor PID control:

Defines the maximum working frequency of the variable compressor in automatic control mode (PID algorithm).

Note: check the technical manual of the variable compressor.

[F76] - Maximum operating frequency of the variable compressor:

Defines the maximum operating frequency of the compressor. This frequency is used when it is necessary to quickly cool the controlled environment, e.g., high room temperature, Fast Freezing process or after a defrost cycle.

Note: check the technical manual of the variable compressor.

[F77] - Compressor stop frequency (switch-off):

Defines the output frequency to inform the compressor to stop. This frequency is lower than the minimum working frequency.

Note: check the technical manual of the variable compressor.

Note: If [F66] = 3, the value configured in this parameter is ignored and considered as 0%.

[F78] - Variable compressor frequency during hot gas defrost:

Sets the variable compressor frequency during the hot gas defrost process.

[F79] - Variable compressor frequency in case of error in sensor S1 (room temperature):

Defines the frequency of the variable compressor if an error is detected for temperature sensor S1 (room sensor). This parameter works together with [F69] and [F70].

[F80] - Variable compressor soft start frequency:

When switching on the variable compressor, it is kept at a low speed for a few seconds, as set in [F81]. The purpose of this feature is to improve the lubrication of the compressor.

[F81] - Variable compressor soft start time:

Time the variable compressor will be on at the soft start frequency. The purpose of this feature is to improve the lubrication of the compressor.

[F82] - Variable compressor on time after reaching the setpoint:

After reaching the temperature setpoint, it is possible to keep the compressor running at a speed calculated by the PID control algorithm. The purpose is to avoid successive starts of the compressor, obtaining a reduction in energy consumption (energy efficiency) as well as low oscillation of the room temperature (sensor S1). If set to [0FF], the variable compressor is switched off immediately after reaching the temperature setpoint. If set to [0n], the compressor is switched off and will start again according to the setpoint and the control hysteresis.

[F83] - Variable compressor time below F85 limit frequency for lubrication:

Time in which the variable compressor must be on with the frequency below the limit set in [F85] to operate at the frequency set in [F76] for the time set in [F84].

This process of periodic acceleration of the control frequency promotes lubrication of the variable compressor through the migration of the lubricating oil.

[F84] - Variable compressor time on frequency F76 for compressor lubrication:

Time that the variable compressor will stay on at the frequency defined in [F76] for lubricating the compressor.

[F85] - Minimum frequency for variable compressor lubrication control:

Limit frequency for the instrument to use the variable compressor lubrication process.

[F86] - Maximum time of variable compressor on at maximum frequency:

Maximum time for the variable compressor at maximum frequency. This parameter works together with [F76].

[F87] - Low temperature limit (differential for the temperature setpoint):

Sets the low temperature limit to be used to turn off the variable compressor. In this parameter, the differential for the setpoint is adjusted.

Example: Setpoint = [-6.0] and [F87] = [3.0]. In this case, the temperature limit for turning off the compressor will be [-9.0] (-6.0 - 3.0).

[F88] - High temperature limit (differential for the temperature setpoint):

Sets the high temperature limit to activate the variable compressor at its maximum operating frequency. The purpose of this parameter is to quickly lower the temperature of the controller environment. In this parameter, the differential for the setpoint is adjusted. The hysteresis of this parameter is fixed at 1.0°C (1.8°F).

Example: Setpoint = [-6.0] and [F88] = [11.0]

In this case, the compressor will operate at maximum speed [F76] when the temperature is above [5.0] (-6.0 + 11.0), and will return to normal speed operation (between [F74] and [F75] when the temperature is below [4.0] (-6.0 + 11.0 - 1.0).

[F89] - AUX output mode:

- [0] - Output off;
- [1] - Lamp; Controls lighting;
- [2] - Alarm;
- [3] - Door resistance (without S3 sensor): The door heater remains on, regardless of the door temperature. The resistor is turned off only during the occurrence of alarms;
- [4] - Door resistance (with S3 sensor): The door resistance to prevent condensation is controlled by the temperature of sensor S3 and the values set in functions [F105] and [F106]. The output is turned off when alarms occur;
- [5] - Schedule: The output is switched on/off on the days and times defined in parameters [F90] until [F95];
- [6] - Cycle reversing valve: The output is turned on to reverse the cooling to heating cycle when the instrument is operating in automatic mode;
- [7] - Auxiliary compressor: The AUX output will be used to drive a second compressor. The AUX output will be activated after the COMP output is activated and the 15 second interval (fixed) has elapsed. The AUX output will always be turned off together with the COMP output.

Note1 (priority 1): If the instrument is configured for automatic mode ([F00]=2), the AUX output is automatically configured for cycle reversing valve. If parameter [F00] is modified, it will be necessary to reset [F89].

Note2 (priority 2): If tray defrost is set to AUX output ([F43]=2), the features of [F89] are ignored.

Note 3 (priority 3): If the gasket control is configured for the AUX output ([F108]=2), the functionalities of [F89] are ignored.

[F90] - Time to turn on the AUX output if [F89] = 5 (Monday to Friday):

[F91] - Time to turn off the AUX output if [F89] = 5 (Monday to Friday):

[F92] - Time to turn on the AUX output if [F89] = 5 (Saturday):

[F93] - Time to turn off the AUX output if [F89] = 5 (Saturday):

[F94] - Time to turn on the AUX output if [F89] = 5 (Sunday):

[F95] - Time to turn off the AUX output if [F89] = 5 (Sunday):

Times to turn the AUX output on/off on weekdays and weekends. To disable this functionality on a specific day, just set the time to turn off with the maximum value [0FF].

[F96] - Operating mode for ambient temperature alarms (S1) (0-relative/1-absolute):

Determines whether the values configured for low ambient temperature [F97] and high ambient temperature [F98] alarm will be relative to the setpoint or absolute values.

[0] - The ambient temperature alarms [F97] and [F98] represent values relative to the setpoint.

Example: Desired temperature [5P] : -5.0°C

Low temperature alarm [F97]: 2.0°C

High temperature alarm [F98]: 2.0°C

Limits: ([5P] - [F97]) and [5P] + [F98].

The low temperature alarm will be signaled at -7.0°C (-5.0°C - 2.0°C) and the high temperature alarm at -3.0°C (-5.0°C + 2.0°C).

[1] - Ambient temperature alarms [F97] and [F98] are absolute values.

Example: Low temperature alarm [F97]: -30.0°C

High temperature alarm [F98]: 15.0°C

The low temperature alarm will be signaled at -30.0°C and the high temperature alarm at 15.0°C.

[F97] - Low ambient temperature alarm (S1):

[F98] - High ambient temperature alarm (S1):

Lower/Upper Ambient Temperature Limits (S1) for the instrument to indicate low/high temperature alarm. The temperatures configured in these parameters can have their absolute or relative values to the setpoint depending on the value configured in [F96]. The differential for alarm shutdown is fixed at 0.1°C/0.1°F.

[F99] - Length of time door is open to trigger alarm:

When the door is opened, the message [0PFn] appears on the display and the door open timer starts. If this time is longer than the time configured in this function, the audible alarm (buzzer) will be triggered and the message [0PPn] will be displayed.

[F100] - Temperature alarm validation time:

This function serves to inhibit the alarm for a period due to an eventual rise in temperature.

[F101] - Alarm inhibition time at power-up:

During this time the alarm remains off while waiting for the system to go back to an operating mode.

[F102] - Maximum time off compressor on without reaching the desired temperature (setpoint):

The alarm is triggered if the compressor remains on without reaching the setpoint, for a longer time than the length specified in this function.

[F103] - Maximum compressor operating time for maintenance alarm (hour meter):

Whenever the compressor (COMP or COMP VCC) is activated, the instrument will count its operating time. When the time counted is greater than or equal to the one set in this function, an alarm will be generated indicating that maintenance on the compressor must be carried out.

[F104] - Trigger for alarm when defrosting is over based on time:

When the defrost cycle has been running for the length of time set, but has not reached the temperature set, the user is notified via a decimal dot in the lower right corner of the display [].

[F105] - Desired temperature for anti-condensation (sensor 3 heating setpoint):

It is the control temperature to avoid condensation of air humidity in the door. When the temperature of the S3 sensor (door) is higher than the value configured in this function, the door resistance will be turned off.

[F106] - Control differential for anti-condensation (S3):

It is the temperature difference between turning the door resistance off and on again to prevent condensation.

[F107] - Enables audible alarm (buzzer):

Enables or disables the internal buzzer to sound alarms.

[F108] - Enables gasket heating control:

[0FF] - Gasket control disabled;

[1] - Gasket control using the COMP output;

[2] - Gasket control using the AUX output.

Note 1: Gasket control is enabled only in cooling mode ([F00]=0) and during the cooling and fan-delay stages.

Note 2: If gasket control is configured to use the COMP output ([F108]=1), the device should be configured to use a variable speed compressor ([F66]=2 or 3).

Note 3: If gasket control is configured to use the AUX output ([F108]=2), observe the priority notes of parameter [F89] for AUX output mode.

[F109] - Temperature limit for gasket heating control activation:

This is the control temperature relative to the setpoint (normal or economic) for gasket control. When the S1 sensor (ambient) temperature is higher than the sum of the current setpoint and the value set in this function, the gasket control will be turned off.

[F110] - Desired temperature differential for gasket heating control:

This is the temperature difference between turning OFF and ON the gasket control.

Example:

- Desired Temperature [5P] : 0°C

- Desired temperature for gasket control [F109]: 1.0°C

- Desired temperature differential for gasket control [F110]: 2.0°C

Limits: ([5P] + [F109] - [F110]) and ([5P] + [F109]).

The control will turn off at 1.0°C (0°C + 1.0°C) and turn back on at -1.0°C (0°C + 1.0°C - 2.0°C).

When the gasket control is on, the output will cycle according to the times defined in parameters [F111] and [F112].

[F111] - Output ON time for gasket heating control:

[F112] - Output OFF time for gasket heating control:

Define the time the output will remain ON/OFF, respectively, if the gasket control is active.

[F113] - High condenser temperature alarm (S3) (visual and audible only):

It is the condenser temperature above which the instrument will indicate visual [0EC1] and audible (buzzer) high temperature alarm. This alarm is ignored until the time configured in [F101] is exceeded.

[F114] - Maximum condenser temperature (S3) to turn off control outputs:

Above this temperature, in addition to the visual alarm [0EC2] and audible (buzzer) alarm indications, the loads driven by the outputs will be switched off. This alarm is ignored until the time configured in [F101] is exceeded.

[F115] - Control differential for maximum temperature in the condenser (hysteresis):

For the loads to be switched on again, the temperature of the S3 sensor (condenser) must drop to the value set in [F114] minus the value set in this parameter. In this condition, the process moves to the refrigeration stage.

[F116] - Time to confirm high pressure alarm:

It is the minimum time that the pressure switch connected to the discharge line must remain activated for this event to be validated. This time serves to avoid unnecessary activations due to pressure fluctuations.

[F 117] - Time to confirm low pressure alarm:

It is the minimum time that the pressure switch connected to the suction line must remain activated for this event to be validated. This time serves to avoid unnecessary activations due to pressure fluctuations

[F 118] - Initial delay time for monitoring low pressure alarm:

Delay time that the suction pressure switch takes to be within its ideal working range when starting the controller, avoiding unwanted alarms.

[F 119] - Delay time after high pressure alarm to resume temperature control:

After the high pressure event, the controller uses this timeout to then regain control.

[F 120] - Delay time after low pressure alarm to resume temperature control:

After the low pressure event, the controller uses this timeout to then regain control.

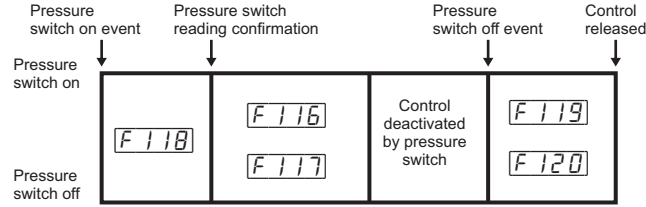

Note 1: At the third event of high or low pressure, within a maximum interval of one hour when starting up the controller, the system displays the message **[H P L O]** - Low pressure switch alarm, which requires the system to be manually reset. To do so, access the quick menu via the **[Q]** key, select **[H P L P]** and short press the **[M]** key to select.

Note 2: Digital inputs must be configured as high/low pressure switches.

Note 3: The times of **[F 114]** and **[F 115]** are independent of the time set in **[F 67]** - Minimum time for compressor on.

[F 121] - Minimum supply voltage (protection):**[F 122] - Maximum supply voltage (protection):**

If the voltage value exceeds the limits set in these functions, an alarm will be generated and the outputs will be turned off.

To disable voltage monitoring, set **[F 121]** greater than **[F 122]**.

Note 1: Voltage monitoring only applies to low voltage models (12 or 24Vac/dc) TC-970ELL Log + Eco or TC-970 EL Log + Eco Faston.

Note 2: When the instrument is being supplied with alternating voltage (Vac), the voltage calculated by monitoring will be equivalent to direct voltage (Vdc).

[F 123] - Voltage indication offset:

Allows you to compensate for possible deviations in the voltage reading.

[F 124] - Voltage validation time:

This time prevents small voltage variations from prematurely turning off the outputs. The outputs will be turned off after the voltage exceeds the working voltage limits and this time has elapsed.

When the voltage returns to acceptable levels, the output will be reconnected after this time has elapsed.

[F 125] - Enables recording of HACCP alarms:

Enables the recording of HACCP alarms as described in item 9.4.6.

- Disables;

- Enables.

[F 126] - HACCP - Low temperature alarm:

It is the temperature above which the instrument will create a HACCP record of type **[H L L O]** as described in item 9.4.6. This configuration is used only for HACCP records, it does not generate an alarm on the alarm output and on the buzzer, as the values related to these specific alarms are configured in their respective functions.

[F 127] - HACCP - High temperature alarm:

It is the temperature above which the instrument will create a HACCP record of type **[H L H O]** as described in item 9.4.6. This configuration is used only for HACCP records, it does not generate an alarm on the alarm output and on the buzzer, as the values related to these specific alarms are configured in their respective functions.

[F 128] - HACCP - Alarm inhibition time:

With this configuration active, the temperature will need to remain in the HACCP alarm condition for the time defined in this function, in order for the alarm to be indicated. In this way it is possible to avoid alerts from specific temperature variations. This setting is only used for HACCP records.

[F 129] - Datalogger operating mode:

Allows you to choose between the following datalogger operating modes:

- Always off;

- Always on;

- Manual operation.

[F 130] - Sampling period (time between records in memory):

Time in seconds that the controller will record a sampling of temperature information, output states, port status and alarm status.

[F 131] - Minimum temperature variation to force writing data to memory:

Temperature difference in relation to the last writing in the datalogger, so that the recording of data in memory is forced regardless of the sampling time configured in **[F 130]**. To deactivate this function, simply decrease the value **[D F F]** is shown on the display.

[F 132] - Variation of digital input or outputs to force writing of data:

Indicates whether changing the digital input or control outputs will force data to be written to memory regardless of the sampling time set in **[F 130]**.

- Off;

- On.

[F 133] - Overwrite old records when memory is full?:

Indicates whether the controller should start writing new data at the beginning of the datalogger's memory when it is full. This avoids losing the last data outputted by the equipment. If set to zero, when the datalogger memory is full, the instrument and Sitrad will report full memory.

[F 134] - Digital filter actuation mode:

- The digital filter acts in the visualization of the display and in the control routines;

- The digital filter acts only in the display view.

[F 135] - Intensity of the digital filter on the room temperature sensor (S1 sensor) (Rising):**[F 136] - Intensity of the digital filter on the room temperature sensor (S1 sensor) (Descending):**

The value adjusted in this function represents the time (in seconds) for the temperature to vary by 0.1°C / 0.1°F on rising or falling temperature.

Note: A typical use for this type of filter is in freezers for ice cream and frozen foods. When the door is opened, a quantity of hot air will fall directly on the sensor, causing a rapid rise in the temperature reading and, often, activating the compressor unnecessarily.

[F 137] - Displacement of the values from the room temperature sensor (S1 sensor):**[F 138] - Displacement of the values from the evaporator sensor (S2 sensor):****[F 139] - Displacement auxiliary sensor indication displacement (S3 sensor):****[F 140] - Displacement auxiliary sensor indication displacement (S4 sensor):**

This allows you to compensate for possible deviations in the reading of the sensor, due to changing the sensor or changing the cable length.

Note: Sensor S2 can be turned off by setting the indication offset to the minimum value until the message **[D F F]** appears. In this condition, all functions dependent on the S2 sensor reading stop operating.

[F 141] - Preferred indication on the display:

- S1 Temperature;

- S2 Temperature;

- S3 Temperature;

- S4 Temperature;

- Current setpoint.

Note: If the measurement is not available (e.g.: sensor deactivated), the message **[E . r d]** will be displayed.

[F 142] - Ambient temperature (S1 sensor) value locked in during defrosting:

- Sensor temperature indication;

- Reading locked in - last temperature before defrosting;

- Indication "**[d E F r]**".

This function is intended to prevent the display reflecting an increase in the room temperature due to defrosting.

[F 143] - Maximum length of time that the temperature is locked in during defrosting:

During the defrosting process, the last temperature measured in the refrigeration cycle or the **[d E F r]** message will be kept on the display. The display will be released when the temperature shown is reached again or the time set for this function has been exceeded, after the start of the next refrigeration cycle (whichever comes first). If set to the value **[D F F]**, the temperature display will be frozen only while defrosting.

[F 144] - Function lock mode:

Enables and configures the Function Lock (see item 9.3.11).

- Function Lock can't be enabled;

- Enables partial blocking, where the control functions will be blocked but the adjustment of the setpoints remain released;

- Enables total locking, leaving only access to the functions of the facilitated menu available.

[F 145] - Function lock period

With this feature active, the parameters are protected against undue changes and are only available for viewing. In this condition, when trying to change these values, the message **[L O L]** will appear on the display.

[F 146] - Turns Off control functions:

When the control functions are turned off, the controller starts to operate only as a temperature indicator with all outputs deactivated. This function can operate in the following ways:

[D F F] - Does not allow the control functions to be turned off;

- Only allows control functions to be turned on or off if the functions are unlocked;

- Allows control functions to be turned on or off even if the functions are locked.



[F 147] - Device address on the RS-485 network:

Address of the instrument on the RS-485 network that enables it to communicate with the Sitrad software.

Note: You may not have any device on the network with the same address.

10. SIGNALS /ALARMS /ERRORS

10.1 Signals

ECO	Operating on the Economic setpoint
oPEn	Open door indication
t-1	Temperature sensor 1
t-2	Temperature sensor 2
t-3	Temperature sensor 3
t-4	Temperature sensor 4
CLD	Adjust / View the date and time
LoPr	Low pressure event
HiPr	High pressure event
dEFr	Temperature locked on defrosting cycle
□	Indicates that the final defrosting temperature has not been reached
 Flashing LED	Tray defrosting in the pre-defrost and drain stages or waiting for the second evaporator to finish defrosting
 Flashing LED	Fast Freezing mode indicated
LDC	Function lock
OFF	Control functions off

10.2 Alarms

RoPn	Open door alarm
AtLo	Low room temperature alarm (sensor 1)
AtHi	High room temperature alarm (sensor 1)
AtC1	High condenser temperature alarm (level 1)
AtC2	High condenser temperature alarm (level 2)
AdIn	External alarm (digital input)
ALrc	Compressor exceeded maximum on time without reaching control temperature (setpoint)
APLo	Low pressure alarm (manual alarm required)
APHi	High pressure alarm (manual alarm required)
ANAI	Compressor maintenance alarm
AuLo	Low voltage alarm
AuHi	High voltage alarm
AdFL	Datalogger memory full
inib	Audible alarm deactivated

10.3 Errors

Err1	Room sensor error: sensor disconnected or damaged
Err2	Evaporator sensor error: sensor disconnected or damaged
Err3	Auxiliary sensor S3 error: sensor disconnected or damaged
Err4	Auxiliary sensor S4 error: sensor disconnected or damaged
ECLO	Clock not set
Eind	Error in choosing the measure to be preferentially displayed on the display. Parameterize function [F14] - Preferred indication on the display.
ENEN	Contact Full Gauge
ECAL	Contact Full Gauge
PPPP	Reset function values

11. GLOSSARY

- °C: Temperature in degrees Celsius.
- °F: Temperature in degrees Fahrenheit.
- **Defr (defrost)**: Defrosting.
- **LOC**: Locked.
- **No**: No.
- **OFF**: Turned Off / deactivated.
- **ON**: Turned On / activated.
- **Refr**: Refrigeration.
- **SET**: set or configure.

12. INTEGRATING CONTROLLERS, RS-485 SERIAL INTERFACE AND COMPUTER

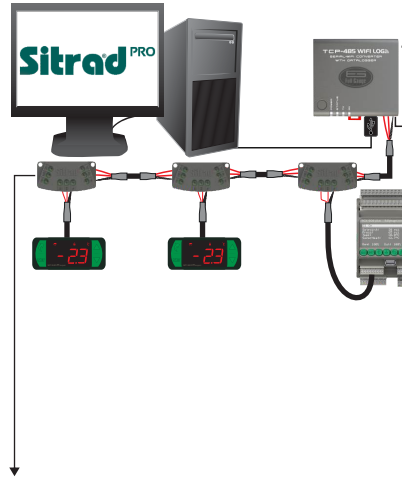

*INTERFACE SERIAL RS-485

Device used to establish the connection of Full Gauge Controls instruments with Sitrad®.

Product NOT compatible with:

- TCP-485 versions earlier than 4.01;
- TCP-485 WiFi version 1;
- TCP-485 WiFi Log version 1.

Full Gauge offers different interface options, including technologies such as USB, Ethernet, Wifi, among others.

For more information, consult Full Gauge Controls.

Sold separately.

MODBUS PROTOCOL

The controller allows you to configure the RS-485 communication port for the MODBUS-RTU protocol. For more information about the implemented commands and the registration table, contact Full Gauge Controls.



CONNECTION BLOCK

It is used to connect more than one controller to the Interface. The wire connections must be made as follows: Terminal **A** of the controller connect to terminal **A** of the connection block, which in turn, must be connected to terminal **A** of the Interface. Repeat the procedure for terminals **B** and $\frac{1}{2}$, being $\frac{1}{2}$ the cable screen.

The **TC970E Log +ECO** and **TC970E Log +ECO Faston** allows you to configure the RS-485 communication port for the MODBUS-RTU protocol. For more information about the implemented commands and the registration table, contact Full Gauge Controls.

13. OPTIONAL ITEMS - Sold separately

EasyProg - version 6 or higher

This is an accessory, whose main function is to store the parameters of the controllers. You can load new parameters from a controller at any time, and download them to a production line (from the same controller), for example.

It has three types of connection for loading or clearing parameters:

- **Serial RS-485**: Connect it to the controller using the RS-485 network (only controllers that can access RS-485).
- **USB**: If connected to the computer by a USB port, it can use Sitrad's Program Editor.
- **Serial TTL**: The controller can connect directly to

EasyProg by a Serial TTL connection.

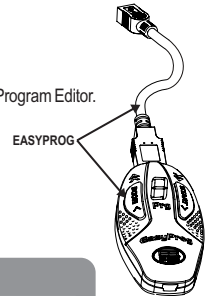

IMPORTANT



- TO COMMUNICATE WITH EASYPROG, THIS EQUIPMENT MUST NOT BE COMMUNICATING WITH THE SITRAD SOFTWARE.
- PLEASE NOTE THAT THE PRODUCT WILL ONLY BE COMPATIBLE WITH EASYPROG 6.

Extended Panel

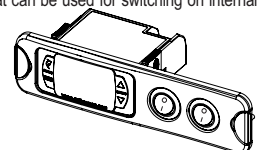

Full Gauge Controls extended panel allows controllers to be installed in Evolution and Ri lines (the opening must measure 71x29mm for the extended panel to be installed), as the opening does not need to be precise for the device to be properly installed. The panel has space to be branded with the company logo and contact information, and it has 10A switches (250 V ac) that can be used for switching on internal lighting, ventilation or fan systems.

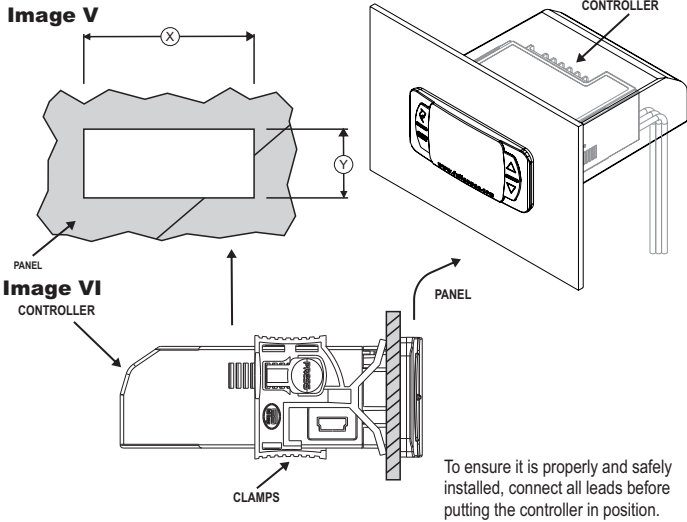

14. ANNEXES - Reference Diagrams



15. WARRANTY

ENVIRONMENTAL INFORMATION

Packaging:
The materials used in the packaging of Full Gauge products are 100% recyclable. Try to perform disposal through specialized recyclers.

Product:
The components used in Full Gauge controllers can be recycled and reused if disassembled by specialized companies.

Disposal:
Do not incinerate or dispose the controllers that have reached the end of their service as household garbage. Observe the laws in your area regarding disposal of electronic waste. If in doubt, please contact Full Gauge Controls

WARRANTY - FULL GAUGE CONTROLS

Products manufactured by Full Gauge Controls, as of May 2005, have a two (02) year warranty, as of the date of the consigned sale, as stated on the invoice. They are guaranteed against manufacturing defects that make them unsuitable or inadequate for their intended use.

EXCEPTIONS TO WARRANTY

The Warranty does not cover expenses incurred for freight and/or insurance when sending products with signs of defect or faulty functioning to an authorized provider of technical support services. The following events are not covered either: natural wear and tear of parts; external damage caused by falls or inadequate packaging of products

LOSS OF WARRANTY

Products will automatically lose its warranty in the following cases:

- The instructions for assembly and use found in the technical description and installation procedures in Standard IEC60364 are not obeyed;
- The product is submitted to conditions beyond the limits specified in its technical description;
- The product is violated or repaired by any person not a member of the technical team of Full Gauge Controls;
- Damage has been caused by a fall, blow and/or impact, infiltration of water, overload and/or atmospheric discharge.

USE OF WARRANTY

To make use of the warranty, customers must send the properly packaged product to Full Gauge Controls together with the invoice or receipt for the corresponding purchase. As much information as possible in relation to the issue detected must be sent to facilitate analysis, testing and execution of the service

These procedures and any maintenance of the product may only be provided by Full Gauge Controls Technical Support services in the company's headquarters at Rua Júlio de Castilhos, 250 - CEP 92120-030 - Canoas - Rio Grande do Sul - Brasil

Rev. 03