

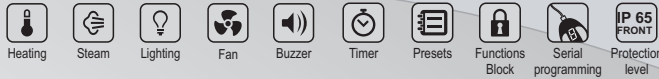

Have this manual in your hand using the FG Finder app.



- BEFORE INSTALLING THE CONTROLLER, WE RECOMMEND THAT YOU FULLY READ THE INSTRUCTION MANUAL TO PREVENT POSSIBLE DAMAGE TO THE PRODUCT.
- THROUGH CONTINUOUS DEVELOPMENT, FULL GAUGE CONTROLS RESERVES THE RIGHT TO CHANGE THIS MANUAL INFORMATION AT ANY TIME WITHOUT PRIOR NOTICE.
- THIS CONTROLLER IS NOT RESPONSIBLE FOR SAFETY WITH RESPECT TO ANY FLAME SENSOR, GAS VALVE, OR SPARK IGNITER OF WHICH NEED TO HAVE SAFETY CERTIFICATES (RECOGNIZED IGNITION AND GAS MODULE) IN ITS APPLICATION FOR FINAL USE. THE FLAME SENSOR, THE GAS VALVE OR SPARK IGNITER IN THIS CONTROL WILL BE CONSIDERED SEPARATELY FROM THE THERMON CONTROLLER.

1. DESCRIPTION

Thermostat and timer for the automation of forced convection ovens. This model provides control over gas, electric, or wood powered ovens, configured through the setup menu. The preset mode provides 20 configurations to control the temperature, cooking time, and steam injection, making the oven ready for the most varied types of cooking. TO-711B allows reversing the rotation direction of the fan to improve the uniformity of the roast. The instrument also controls steam injection and lighting in the oven, and has an internal audible alarm (buzzer) that signals, for example, the end of the roasting process. It also allows for the use of an external audible alarm and temperature sensor for thermal protection of the fan, preventing it from overheating. The ThermON line is developed and produced with high-quality raw materials and stands out for its unique and differentiated design and intuitive, user-friendly interface to facilitate operation and configuration. It offers a functions lock feature to prevent third parties from changing the parameters, air-tight front panel that provides high protection against the entry of dirt and moisture, and more.

2. APPLICATIONS

Baking ovens, stoves;

3. TECHNICAL SPECIFICATIONS

Power supply / Approximate consumption	TO711B: 85~240Vac ± 10% (50-60Hz) / 10VA
Operating temperature / Control temperature	0 to 131°F (0 to 55°C) / 14 to 932°F (-10 to 500°C)
Temperature sensor	Type J or K thermocouple (sold separately)
Thermal protection sensor	Fan PTC (sold separately)
Resolution	1°C / 1°F
Digital Input	E1: door micro switch input or external alarm (buzzer)
Flame sensor	E2: remote timer trigger E3: flame sensor input
Relay outputs	6 relay outputs: 5 (3)A / 250Vac 1/8HP
External audible alarm (buzzer) outputs	12Vcc / 30mA (max)
Product dimensions / Cutout dimensions (mm)	75 x 75 x 100 (WxHxD) / 67.2 x 67.2
Operating humidity	10 to 90% UR (without condensation)

4. INTRODUCTION

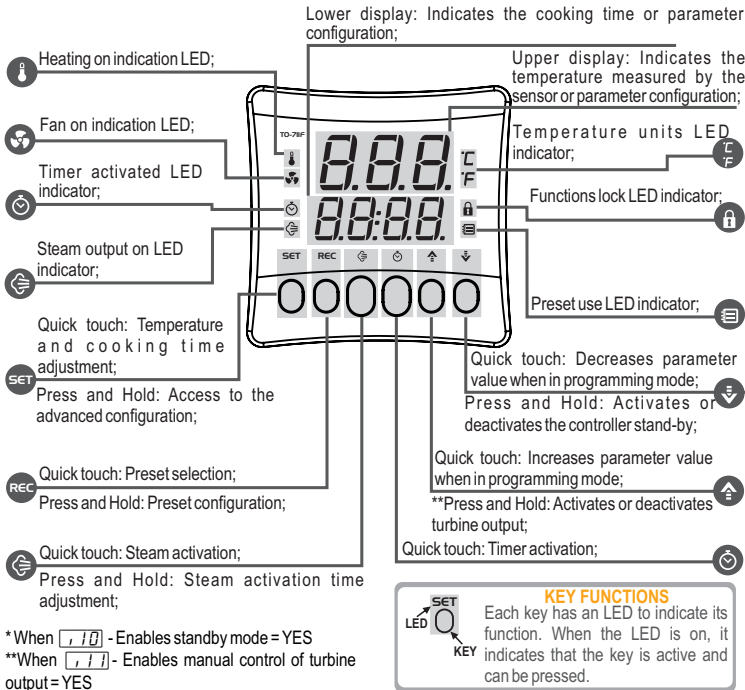

*When [11] - Enables standby mode = YES
**When [11] - Enables manual control of turbine output = YES

5. INSTALLATION CONFIGURATION

Access the installation configuration menu by pressing the SET key for 4 seconds until [F000] is displayed. When [F000] is displayed press the SET key again (quick touch). Use the ↑ or ↓ keys to enter the access code 231 and press SET (quick touch) again when ready.

Use the ↑ or ↓ keys to select the desired function. The value can be edited with a quick touch on the SET key. Use the ↑ or ↓ to change the value and press the SET key with a quick touch when ready to save the configured value and return to the functions menu. To leave the configuration menu and return to the normal operating mode (temperature indication), press SET (press and hold) until [---] is displayed.

5.1 Installation setup table

FUN	FUNCTION	DESCRIPTION	MIN	MAX	UNIT	DEFA
[C00]	Access Code (231)	Required when you want to change installation setup parameters.	0	9999	-	0
[101]	Oven type selection	Selects the control type of the oven: [ELE] = Electric Oven [GAS] = Gas-fired Oven [WOOD] = Wood-fired Oven	ELE	LEN	-	GAS
[102]	Temperature sensor type	Defines the type of temperature sensor to be used with the controller.	tc_J	tc_H	-	tc_J
[103]	Unit selection of temperature	Selects the temperature unit the controller will use for its operation	°C	°F	-	°C
[104]	Language selection	Selects the language the controller will use to display messages: [POR] = Portuguese [ENG] = English [ESP] = Spanish	PORT	ESP	-	PORT
[105]	Enables external sound alarm (buzzer)	Enables or disables the external audible alarm (buzzer). If enabled, the internal audible alarm (buzzer) will be disabled.	OFF	ON	-	OFF
[106]	Internal audible alarm (buzzer) volume	Selects the sound intensity of the internal audible alarm (buzzer) [LOW] = low volume [MED] = medium volume [HIGH] = high volume	MIN	HIGH	-	HIGH
[107]	Digital input signal type	[NO] - normally open contact (NO) [NC] - normally closed contact (NC)	NO	NC	-	NO
[108]	Digital input mode	Allows you to configure whether the digital input will be used as an input for a door sensor or as a digital input for high temperature alarm: [DOOR] = Door sensor input; [ALARM] = High temperature external alarm input. NOTE: When configured as a high temperature alarm input, the other functionalities related to the door sensor consider that the door is always closed.	door	Alarm	-	door
[109]	Enable fan thermal protection	If enable, monitors fan temperature. In case of overheating, enters error mode, switching off the outputs of the controller. [ON] = Fan thermal protection enable [OFF] = Fan thermal protection disable.	OFF	ON	-	OFF
[110]	Enables stand-by oven functionality	Enables stand-by mode (switching off control functions)	NO	YES	-	NO
[111]	Enables manual control of turbine output	Enabled, it allows the turbine output to be deactivated or activated by the user manually, always respecting the times set in parameters [F27] and [F28].	NO	YES	-	NO

6. OPERATION

6.1 Oven: electric

In this operating mode the controller keeps the heating output on until the oven reaches the oven temperature setpoint (SP). The heating output will be activated again when the temperature drops below the setpoint minus the hysteresis [F04].

6.2 Oven: gas

In this operating mode the controller automates / monitors the flame ignition and thus the heating of the oven through the activation of the gas output, ignition module, and flame sensor input. The controller keeps the heating on until the ovens reaches the oven temperature setpoint (SP). Heating will be activated again when the temperature drops below the setpoint minus the Hysteresis [F04]. The controller permanently monitors the flame sensor to ensure the safe operation of the gas-fired oven. In this way, if there are any abnormalities, errors [E04] - Flame Sensor shorted with the burner and [E05] - Lack of Flame are indicated. For more information, check item 9 (Signaling).

6.3 Oven: wood

In this operating mode the heating output works as an upper threshold alarm, indicating when the temperature exceeds the value adjusted in Oven Temperature setpoint (SP). The audible alarm is also activated to warn the user about the overheating. The output and audible alarm are switched off when the temperature drops below the Oven Temperature setpoint (SP) minus the Hysteresis [F05] or when the SET key in the controller's front panel is pressed.

6.4 Default Mode (standard)

In this operating mode the controller performs the gas type control, however the flame sensor is ignored and the controller will not monitor flame presence. The controller will not detect errors [E04] - shorted flame sensor and [E05] - out of gas, resulting in an operating with less safety. **NOTE: The Default Mode (standard) of operation is available only when the type of oven is adjusted as gas. To execute this operating mode, check item 7.5 Enable Default (standard) Mode of operation.**

IN THIS OPERATING MODE THE FLAME SENSOR IS IGNORED AND THE CONTROLLER WILL NOT DETECT THE PRESENCE/LACK OF FLAME, BEING ESSENTIAL FOR THE OPERATOR TO PAY SPECIAL ATTENTION TO THE CONTROL OF THE OVEN IN ORDER TO PREVENT GAS ACCIDENTS.

7. OPERATIONS - BASIC LEVEL

The controller has easy access to resources that are relevant to the user of the oven.

7.1 Adjustment of oven temperature and timer

To adjust oven temperature and timer, perform a quick touch on the **SET** key. Use the \uparrow and \downarrow keys to adjust the value of the parameter. To advance and/or terminate the adjustment, perform another quick touch on the **SET** key.



ADJUSTMENT OF THE DESIRED TEMPERATURE (SETPOINT) OF THE OVEN:

Defines the working temperature of the oven. This parameter can be adjusted between the values defined in $[F02]$ - Minimum value allowed to configure the oven temperature setpoint and $[F03]$ - Maximum value allowed to configure the oven temperature setpoint.



TIMER ADJUSTMENT:

Defines the cooking time. When the time expires, the audible alarm output is switched on intermittently until any key on the controller's front panel is pressed. The timer can be adjusted between 00:01 and 99:59. The time scale is adjusted in parameter $[F16]$ - Time base of the timer.

NOTE: When the $[F13]$ - Disable timer function is set to $[4E5]$, the timer setting will not be available in this menu.

7.2 Steam activation

The steam operating mode is defined in parameter $[F20]$ - Steam Operating Mode. Steam activation depends on parameters $[F22]$ - Time interval between steam activations and $[F23]$ - Minimum temperature to activate the steam, available in the advanced configuration menu. These conditions must be met for the injection of steam in the oven to occur.

7.2.1 Steam activation times

Press the \odot key and hold for 4 seconds to adjust. Use the \uparrow and \downarrow keys to adjust the value of the parameter. To confirm, perform a quick touch on the \odot key.

FAN CONTROL MODE:



Selects turbine control mode:

$[0n]$ = On, the turbine is controlled by the TURBINE 1 output.

$[Alt]$ = Alternate, toggles the direction of rotation of the turbine through the TURBINE 1 and TURBINE 2 according to the setting of parameters $[F25]$ and $[F26]$.

Turbine Shutdown Option: If $[11]$ - Enables Manual Turbine Output Control to be set to "YES", you can temporarily disable the turbine output by pressing \uparrow for approximately 2 seconds. The turbine output will remain disabled respecting the time set in function $[F27]$ - Maximum turbine off time after deactivation, allowing the turbine to remain off for 1 to 60 minutes. The turbine can be reactivated at any time by the user by pressing the \uparrow key again for 2 seconds.

While the turbine is off, the \odot icon will keep flashing on the display. Once the turbine is restarted automatically or by the user, a new shutdown will only be allowed respecting the time set in function $[F28]$ - Minimum turbine on time between manual shutdown to prevent the oven from staying too long with the turbine off. You can set a time of up to 20 minutes or disable this function by moving the setting to the minimum until $[no]$ appears on the display.



STEAM OUTPUT ON TIME:

This parameter can be adjusted between 1 and 30 seconds, and the factory default is 3 seconds.



STEAM OUTPUT OFF TIME:

This parameter can be adjusted between 1 and 600 minutes, and the factory default is 5 minutes.

NOTE: This parameter is available for adjustment when the steam control mode selected is cyclic $[F20]=[49C]$.

7.3 Presets

A preset includes the configuration of oven temperature, timer, and steam operating mode. The controller has 20 presets that can be edited by the user, and the presets can be selected in a simplified way.

7.3.1 Preset selection



To select a preset in the controller, perform a quick touch on the **REC** key and then use \uparrow or \downarrow to select the desired preset.

REC - QUICK TOUCH: cancel preset selection;

REC - PRESS AND HOLD: confirm preset selection;

The \odot icon indicates that the preset mode is active.

7.3.2 Preset configuration

To access the preset configuration menu, keep the **REC** key pressed down for 4 seconds. Then use \uparrow or \downarrow to select the parameter to be adjusted, use the **REC** key to access the parameter, and then use \uparrow or \downarrow to adjust the value of the parameter. To leave the preset menu and return to the normal operating mode (temperature and time indication), keep the **REC** key pressed down (press and hold) until $[---$] is displayed.

7.3.2.1 Preset configuration table

FUN	FUNCTION	DESCRIPTION	MIN	MAX	UNIT	DEFA
$[cLnF]$	Select the preset to be configured	Selects the number of the preset to be configured. There are 20 presets that can be customized by the user.	1	20	-	1
$[cSp]$	Oven temperature setpoint for the selected preset	Adjustment of the oven temperature setpoint for the preset selected by parameter (F02) $[cLnF]$.	(F02)	(F03)	°C (°F)	180 (356)
$[cTn]$	Timer adjustment for the selected preset	Adjustment of the timer for the preset selected by parameter $[cLnF]$.	00:01	99:59	F16	18:00
$[cUR]$	Steam operating mode for the selected preset	Defines the steam operating mode for the selected preset $[cLnF]$: $[0FF]$ Off: does not inject steam. $[MAN]$ Manual: injects steam when the \odot key is pressed. $[AUT]$ Automatic: automatically injects steam after the timer is activated. The steam is activated after the time set in $[F21]$ has elapsed. $[CYC]$ Cyclic: injects steam in cycles using the times configured in $[URon]$ and $[URof]$.	OFF	CYC	-	MAN

7.4 Function Lock



To enable / disable the function lock, press \uparrow and \downarrow and hold for the time configured in parameter $[F30]$ - Time for function lock.

When this configuration is active, the parameters cannot be changed, but they can be viewed. When the lock is active, the parameters available for adjustment are defined in parameter $[F29]$ - Functions Lock.

Icon \odot indicates the status of the lock. Icon \odot indicates the functions lock is active.

7.5 Enable Default (standard) operating mode



To enable the Default (standard) operating mode of the oven, the controller must be powered up with the \odot and \odot keys pressed until the message appears on the display. This mode is available when the type of oven selected is GAS. For more details about this operating mode check item 6.4 Default Mode (standard).



IN THIS OPERATING MODE THE FLAME SENSOR IS IGNORED AND THE CONTROLLER WILL NOT DETECT THE PRESENCE / LACK OF FLAME, BEING ESSENTIAL FOR THE OPERATOR TO PAY SPECIAL ATTENTION TO THE CONTROL OF THE OVEN IN ORDER TO PREVENT GAS ACCIDENTS

7.6 STAND-BY Function

When function $[11]$ - Enable stand-by oven functionality is set to YES, the controller can be put on standby at any time by the user. This functionality allows for the control to be kept disable (all outputs off). To put the controller on stand-by mode, press \downarrow for approx. 4 seconds, until the message $[0FF]$ is displayed.

While the controller is on stand-by, the display will flash the \downarrow key icon to indicate for the key to be pressed again for 4 seconds to reactivate the oven control.

8. OPERATIONS - ADVANCED LEVEL

8.1 Changing the controller parameters



Access the advanced configuration menu by pressing the **SET** key for 4 seconds until $[Fnc]$ is displayed. When $[cOd]$ is displayed press the key again (quick touch). Use the \uparrow or \downarrow keys to enter the access code 123 and press **SET** (quick touch) again when ready.

Use the \uparrow or \downarrow keys to select the desired function. The value can be edited with a quick touch on the **SET** key. Use the \uparrow or \downarrow keys to change the value and press the key with a quick touch when ready to save the configured value and return to the functions menu. To leave the configuration menu and return to the normal operating mode (temperature and time indication), press **SET** (press and hold) until $[---$] is displayed.

8.2 Parameters table

FUN	FUNCTION	DESCRIPTION	MIN	MAX	UNIT	DEFA
$[cOd]$	Access Code (123)	Required when you want to change the advanced configuration parameters.	0	9999	-	0
$[F01]$	Temperature sensor indication offset	Allows compensating deviations in the sensor temperature reading.	-20 (-4)	20 (36)	°C (°F)	0 (0)
$[F02]$	Minimum value allowed to configure the oven temperature setpoint	These parameters serve as the lower and upper thresholds for the adjustment of parameter "SP" - oven temperature setpoint. They are used to block temperature adjustments and to avoid an improper configuration for the operation of the oven.	-10 (14)	F03 (°F)	°C (°F)	0 (32)
$[F03]$	Maximum value allowed to configure the oven temperature setpoint		F02 (932)	500 (°F)	°C (°F)	230 (446)
$[F04]$	Oven temperature differential (Hysteresis)	The temperature difference to switch on the heating output. This function allows defining a temperature interval within which the heating output will remain off.	1 (1)	20 (36)	°C (°F)	3 (5)
$[F05]$	Delay to switch off the temperature control when the door of the oven is opened	Defines the delay to switch off the temperature control when the oven door is opened to allow furnishing the oven without switching off the control. To disable this function, change the adjustment to the minimum until $[no]$ is displayed. In this case, the temperature control is switched off as soon as the door is opened.	no(0)	180	sec.	90
$[F06]$	Number of attempts to light the flame (GAS-FIRED OVEN)	Defines the maximum number of attempts the controller will try to ignite the flame. After using up all attempts, the controller will signal error $[E-5]$ - Out of Gas. Note: This parameter is used when the type of oven selected is GAS.	1	5	-	3
$[F07]$	Ignition output on time (GAS-FIRED OVEN)	Defines the time the ignition output will stay switched on to try to ignite the flame. Note: This parameter is used when the type of oven selected is GAS.	1	15	sec.	3
$[F08]$	Interval between activations of the ignition output (GAS-FIRED OVEN)	Defines the interval between attempts to activate the flame. Note: This parameter is used when the type of oven selected is GAS.	1	15	sec.	3
$[F09]$	Delay to activation of the ignition output after controller start up (GAS-FIRED OVEN)	Defines the delay to activate the ignition output after the gas output is activated in the first attempt to ignite the flame. This time is used so that the gas from the cylinder reaches the burner and then the ignition is activated. Note: This parameter is used when the type of oven selected is GAS.	no (0)	15	sec.	no(0)
$[F10]$	Delay of the temperature control after controller start up (GAS-FIRED OVEN)	When the controller is powered up, the fan is activated first and then the flame ignition process commences after the time adjusted in this parameter has elapsed. Note: This parameter is used when the type of oven selected is GAS.	no (0)	30	sec.	1
$[F11]$	Delay of the temperature control (GAS-FIRED OVEN)	When the controller tries to ignite the flame, for example after the door is opened, the fan is activated first and then the flame ignition process commences after the time adjusted in this parameter has elapsed. Note: This parameter is used when the type of oven selected is GAS.	no (0)	30	sec.	5





FUN	FUNCTION	DESCRIPTION	MIN	MAX	UNIT	DEFA
[F12]	Disables temperature control at the end of the timer	Allows you to deactivate the temperature control at the end of the timer countdown. However, the control will only be turned off if the function [F13] - Disable timer is configured as NO and the function [F14] - Timer trip mode is configured as MANUAL, to avoid an incorrect operation of the temperature control.	NO	YES	-	NO
[F13]	Disable timer	It allows disabling the timer, not allowing manual or automatic triggering. Neither the timer icons nor the digits on the lower display will be shown, only the parameter settings and other controller messages.	NO	YES	-	NO
[F14]	Timer trigger mode	Defines the timer triggering mode: [F14.1] = Manual, through the Ⓞ key or E2 - Digital input of remote timer trigger. [F14.2] = Start up, when the controller is powered up. [F14.3] = Temperature, when the oven working temperature is reached. [F14.4] = Temperature, when the oven reaches the operating temperature, the control remains active; however, after the timer finishes, the control is turned OFF (single-cycle mode), and it is necessary to turn the controller back ON to start a new heating cycle. Note: In modes [F14.1], [F14.3], and [F14.4], the key Ⓞ or E2 - Remote timer trigger digital input only cancel the timer.	MAN	TMP2	-	MAN
[F15]	Timer counting direction	Defines the direction the timer counts: [F15.1] = time count down; [F15.2] = time count up;	DEC	CRE	-	DEC
[F16]	Timer time base	Defines the time base of the timer: [F16.1] = minutes, maximum time 99:59 minutes; [F16.2] = hours, maximum timer 99:59 hours.	MM:SS	HH:MM	-	MM:SS
[F17]	Timer reset mode	Defines the timer reset mode, essentially whether the audible alarm will be switched off manually or by time: [F17.1] = Manually through the Ⓞ key or E2 - Digital input of remote timer trigger; [F17.2] = Automatically according to the time defined in parameter [F19]; Note: The timer reset also occurs when the oven door is opened, regardless of the mode selected in this parameter, except when function F14 is set to [F14.4], which does not allow timer reset, requiring the controller to be turned back ON.	MAN	AUT	-	MAN
[F18]	Timer reset time base	Defines the time base when the timer is reset: [F18.1] = minutes, maximum time 99:59 minutes; [F18.2] = hours, maximum time 99:59 hours.	MM:SS	HH:MM	-	MM:SS
[F19]	Time to reset the timer (aut mode)	Defines the time to reset the timer if automatic reset is selected in parameter [F17].	0:01	99:59	F18	0:05
[F20]	Steam working mode	Defines the steam operating mode for the selected preset [F20.1]: [F20.1.1] Off: does not inject steam. [F20.1.2] Manual: injects steam when the Ⓞ key is pressed. [F20.1.3] Automatic: automatically injects steam after the timer is activated. The steam is activated after the time set in [F21] has elapsed. [F20.1.4] Cyclic: injects steam in cycles using the times configured in [F22.1] and [F22.2]. Note: When the preset mode is active, this configuration is made in menu [F23].	OFF	CYC	-	MAN
[F21]	Delay to activate the automatic steam	Defines the delay before injecting steam into the oven after the timer is activated. This parameter is valid when automatic steam is adjusted in parameter [F20].	1	999	sec.	5
[F22]	Time interval between steam activations	Defines the minimum time interval between steam activations, i.e. once the steam output is activated, the controller will not activate it again before the time adjusted in this parameter has elapsed. To disable this function, change the adjustment to the minimum until [no] is displayed. Note: This parameter is disregarded when the type of steam selected is cyclic.	no(0)	30	min.	no(0)
[F23]	Minimum temperature to activate the steam	Defines the minimum temperature in the oven to allow activating the steam output. To disable this function, change the adjustment to the minimum until [no] is displayed.	no(-10)	500	°C	100

FUN	FUNCTION	DESCRIPTION	MIN	MAX	UNIT	DEFA
[F24]	Economic mode - oven idle time to switch of the light	Defines the time the oven has to be idle before the controller enters in Economic Mode (ECO). When the lightbulb output is switched off. Press SET to leave the ECO mode.	no(0)	60	min.	15
[F25]	Fan output on time	Defines the time the fan will stay active in each direction.	60	600	sec.	180
[F26]	Fan output off time	It must be adjusted with the time required for the fan to stop, so that the rotation reversion can be performed smoothly.	5	30	sec.	15
[F27]	Maximum turbine off time after shutdown	Determines the maximum time that the turbine output will remain off after manual shutdown (if [F27] is set to YES). This setting allows the turbine to automatically restart without user intervention. Note: The turbine can be manually restarted by the user at any time.	1	60	min.	20
[F28]	Minimum turbine on time between new manual shutdown:	Allows you to set the minimum turbine on time before performing a new manual shutdown. This way the user can only turn off the turbine after the time set in this function has elapsed. To disable this function, move the setting to the minimum until [no] appears on the display.	no(0)	20	min.	10
[F29]	Functions lock	Defines the functions lock mode: [F29.1] = functions lock disabled; [F29.2] = partial functions lock 1 - prevents advanced configuration parameters from being changed; [F29.3] = partial functions lock 2 - prevents controller parameters from being changed, only allowing changing presets; [F29.4] = full functions lock, does not allow any parameter adjustment.	OFF	FULL	-	LOC1
[F30]	Timer for function lock	Defines the time to lock / unlock the functions. For more information, see item 7.4 - Functions Lock.	1	30	sec.	10



9. SIGNALING

9.1 Operating mode signaling

Upon power up the controller indicates the operating mode of the oven.





	Electric Oven Controller configured with the electric oven logic.
	Gas-fired Oven Controller configured with the gas-fired oven logic.
	Wood-fired Oven Controller configured with the wood-fired oven logic.
	Default Mode (standard) Controller configured with gas-fired oven logic with Default (standard) mode enabled, without flame sensor monitoring. For more information, see item 7.5 Enable Default (standard) operating mode.

9.2 Programming signalization

	Functions lock active Does not allow adjusting the parameter To deactivate functions lock, see item 7.4 - Functions lock.
	Parameter adjustment denied Enter access code in parameter [no] to adjust the parameter value.
	Receiving data via EasyProg* (programming key) Updating the parameter table via EasyProg*. *sold separately

9.3 Process signaling

If the controller detects an error that interferes in the operation of the system, the controller switches off the outputs, switches on the audible alarm intermittently, and indicates the detected failure on the display. To leave error mode, the controller must be switched off, the fault corrected, and the controller switched on again.
Note: In case the [F10] - **Enable stand-by oven functionality** function has been set as YES, press the ↵ key during the error signaling to put the controller in stand-by and reboot it after the informed error is corrected.

	Measure: Contact Full Gauge Controls.
	Measure: Contact Full Gauge Controls.
	Reason: Temperature sensor disconnected or out of range. Measure: Check sensor connections and operation.
	Reason: Flame sensor shorted with the burner. Measure: Check whether the flame sensor is making contact with the burner.



Reason: Out of gas, the controller does not detect a flame.
Measure: First check if there is gas available for the oven to operate. Check the presence of flame and the distance between the flame sensor and the burner. Other possibilities for this failure are: flame sensor disconnected or dirty / oxidized, damaged ignition module or gas valve.



Reason: External high temperature alarm.
NOTE: Only when the [E, T, B] function is configured as High temperature external alarm.
Measure: Check oven operation and temperature.

9.4 Other signaling



Controller in Economic mode. The controller was idle for the time adjusted in [F 2 4] - Economic Mode. To leave this mode, press **SET** or open the oven door.
Note: This message is displayed alternately with the oven temperature.



Manual turbine shutdown not allowed. The message will be displayed when the time set in function [F 2 8] is not respected before performing a new shutdown.



Performed manual shutdown of the turbine.



Performed manual reclosing of the turbine.



Indicates that the oven door is open.
Note: The message will cycle on the lower display.



Requests for the operator to close the oven door. Indicates that the door remained open for the time configured in parameter [F 0 5]. In this mode the controller switches off the heating and activates the audible alarm.
Note: The message keeps flashing on the lower display.

10. INSTALLATION

10.1 Electrical connections

PRECAUTIONS WHEN INSTALLING THE PRODUCT:

- Before performing any procedure on this instrument, disconnect it from the power grid;
- Ensure that it has adequate ventilation, avoid installation on control panels containing devices that could cause it to operate outside its specified temperature range;
- Install the product away from sources that may generate electromagnetic disturbances, such as: motors, contactors, relays, solenoid valves, etc.

10.1.1 Oven: electric

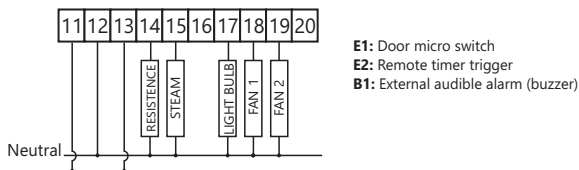
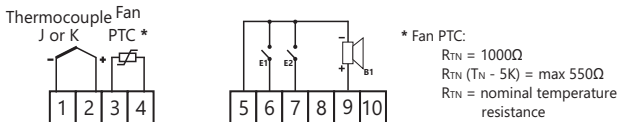

10.1.2 Oven: gas

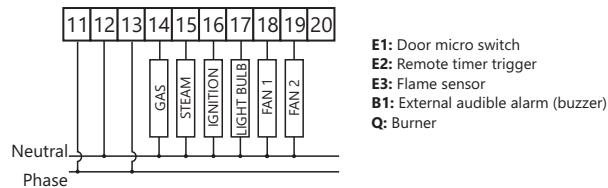
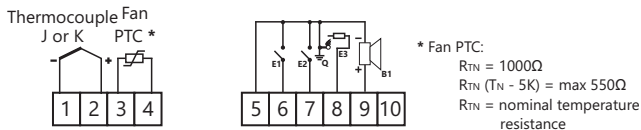

IMPORTANT:

- It is crucial to install the ignition module next to the burner and as far as possible from the electronic controller;
- The ignition electrode must be installed at a distance of 5 mm from the burner;
- The flame sensor must be installed at a distance of 5 mm from the burner and at least 5 mm from the ignition electrode.

10.1.3 Oven: wood

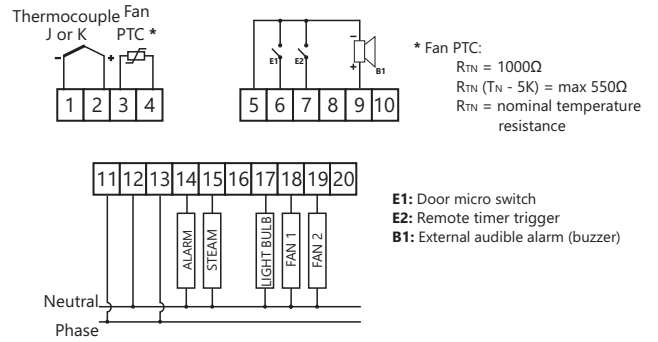

11. DIMENSIONS

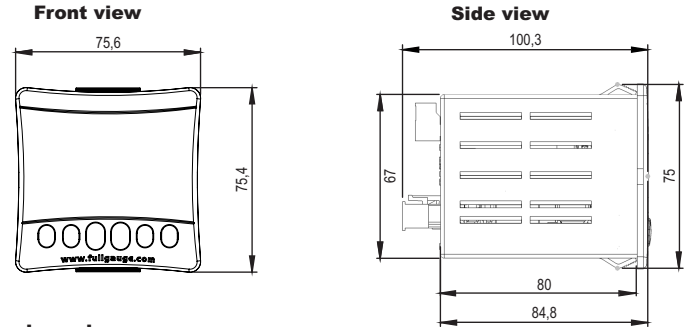

Panel openings

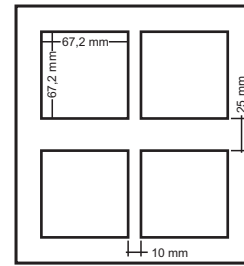

12. EasyProg* - version 02 or later

- Serial RS-485:** It is connected via RS-485 network to the controller (only for those controllers provided with RS-485).
- USB:** It is connected to the computer via USB port, using the Sitrad Preset Editor.
- Serial TTL:** The controller may be connected directly to EasyProg via Serial TTL connection.

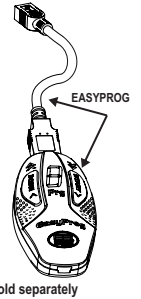

*sold separately



ENVIRONMENTAL INFORMATION

Packaging: Materials used in the packaging of the Full Gauge products are 100% recyclable. Be sure to dispose of using specialized recycling facilities.
Product: The components used in the Full Gauge controllers may be recycled and reused if disassembled by specialized companies.
Disposal: Do not incinerate or dispose of the controllers that reached the end of their service life in household waste. Be sure to comply with the existing legislation in your area relating to disposal of electronic waste. In the event of doubt, please contact Full Gauge Controls.

WARRANTY - FULL GAUGE CONTROLS

Products manufactured by Full Gauge Controls, as of May 2005, have a two (2) - year warranty directly with the factory and one (1) year before the reseller network, counted as of the date of consigned sale as stated on the invoice. After this said year before the reseller network, the warranty shall continue to be executed if the instrument is sent directly to Full Gauge Controls. The products are warranted in case of defects in workmanship making them unsuitable or inadequate to the intended applications. The warranty is limited to maintenance of instruments manufactured by Full Gauge Controls, disregarding other kinds of expenses, such as indemnity for damages caused to other equipment.

EXCEPTIONS TO WARRANTY

The Warranty does not cover expenses incurred for freight and / or insurance for sending the products with signs of defect or malfunctioning to the provider of technical support services. The following events are also excluded from warranty: natural wear and tear of parts, external damages caused by fire or inadequate packaging of products.

INVALIDATION OF WARRANTY

- The product warranty shall lose validity, automatically, if:
 - The instructions for use and assembly contained in the technical description and the installation procedures described in Standard NBR5410 are not followed;
 - The product is submitted to conditions beyond the limits specified in its technical description;
 - The product is violated or repaired by a person not integrating the technical team of Full Gauge;
 - The damages are due to a fall, blow and / or impact, water damage, overload and / or atmospheric discharge.

USE OF WARRANTY

For use of the warranty, the customer should send the adequately packaged product, along with the respective Invoice to Full Gauge Controls. The customer will bear the freight cost for sending of the products. Also, as much information as possible with regard to the defect verified should be sent, in order to facilitate the analysis, the testing and the performance of the service.

These processes and any product maintenance shall only be performed by the Technical Support Services of Full Gauge Controls, at the Company headquarters - Street Julio de Castilhos, 250 - CEP 91210-030 - Canoas - Rio Grande do Sul - Brazil.

Rev. 03